

Optimized performance of shredder systems Reliable driveline technologies



Optimized shredder system Performance with Voith couplings and universal joint shafts

Drivelines in recycling equipment systems are exposed to strains and stresses from a variety of sources. Torque overloads and vibrations are an everyday occurrence. Conventional drive components are often unable to withstand these strains and stresses over extended periods of time and thus driveline damage can occur, leading to unexpected shutdowns and production losses of the equipment.

Checking the drive

For new shredder systems, we calculate all the strains and stresses in the driveline. For existing systems or prototypes, we measure torques and vibrations that occur. By using this diagnostics technology, we identify weaknesses in the driveline.

Finding a solution

Together, we evaluate the calculations and/or measurement results and investigate a driveline solution tailored to the specific system in question. From our product portfolio, we select the components best suited to resolve any weaknesses in the shredder driveline and to ensure maximum reliability.

Creating the advantage

A reliable driveline boosts not only the productivity of the shredder, but also reduces the downtime and associated repair costs. Life-cycle costs are lower thanks to a reduction in maintenance and repair requirements. With system solutions from Voith, your shredder will be an even more cost-effective piece of equipment.

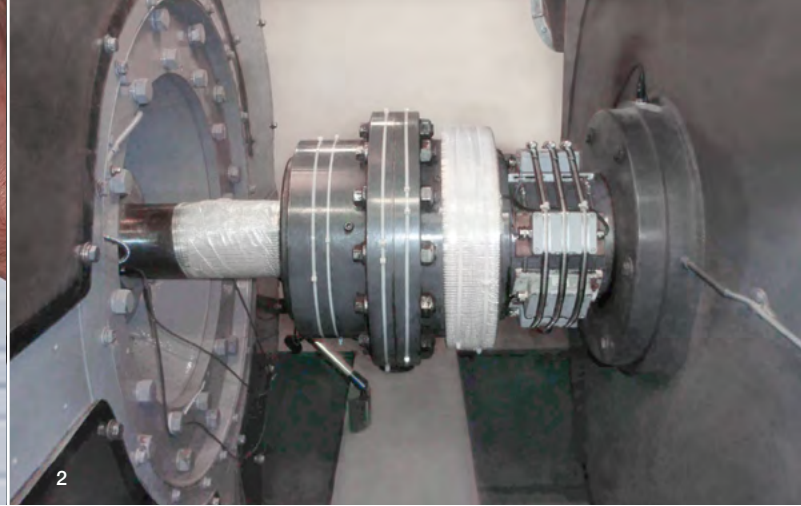

- 1 Service and engineering
- 2 Diagnostics and machine monitoring

Your requirements

Reliable transmission of high power at low speeds

Dampening of load impacts in the driveline

Dampening of vibrations in the driveline

Acceleration of large masses

Protection during overloads

Measurement of unknown forces and vibrations in the driveline

Axial and radial load decoupling

Our solutions

We design the entire driveline, taking the whole system into consideration

Voith couplings dampen torque peaks and limit the torque overloads in the driveline

Voith couplings shift resonance frequencies and dampen vibration amplitudes

Voith couplings permit motor acceleration under no-load conditions and enable the controlled or regulated acceleration of large masses

In an overload situation Voith SafeSet couplings protect machinery from damage by instant disconnection at a precise release torque

We calculate, measure and evaluate all the significant strains and stresses in the driveline

By use of Voith cardan shafts motor and shredder reliable are decoupled against transverse acceleration. The length compensation of the universal joint shaft avoids axial restraint and enables easy assembly

Vibrations occur as a result of continuous excitations of the shredder or for instance when a slip ring motor is synchronized. A highly flexible coupling (driveline design 1) is particularly well suited to damping all critical vibrations. This increases the lifetime of all connected driveline components.

Driveline design 1

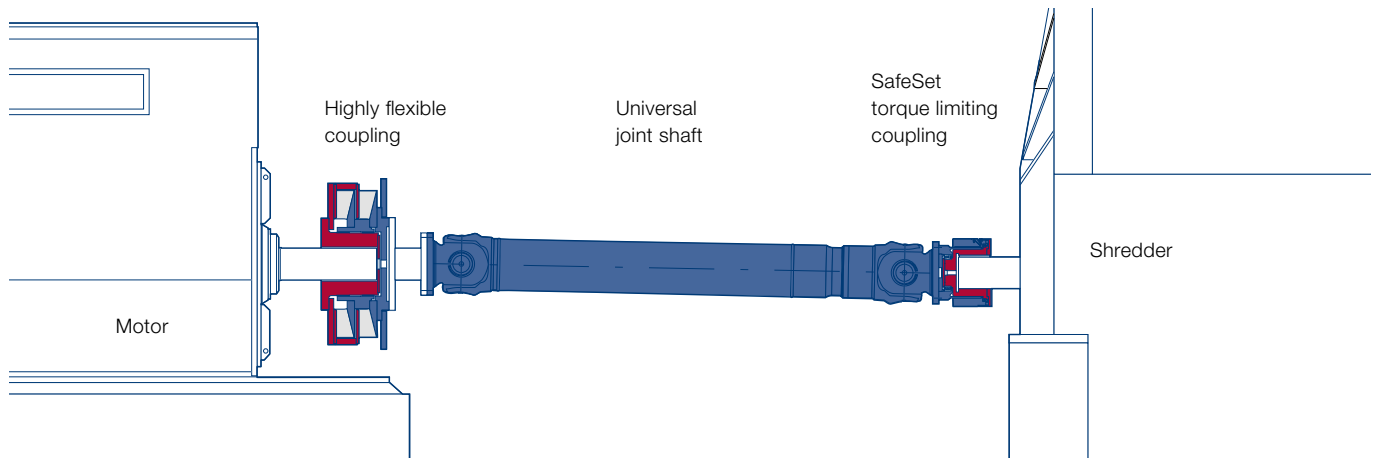

Highly flexible coupling



SafeSet torque limiting coupling

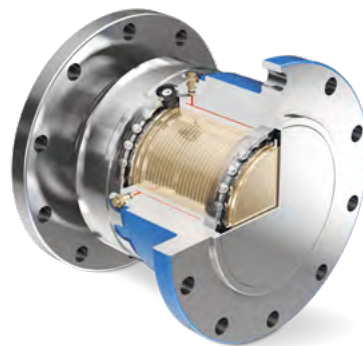

When using an asynchronous squirrel-cage motor, a load-free motor start-up is often required. A fluid coupling (driveline design 2) allows for the motor and the shredder to be initially decoupled.

Driveline design 2

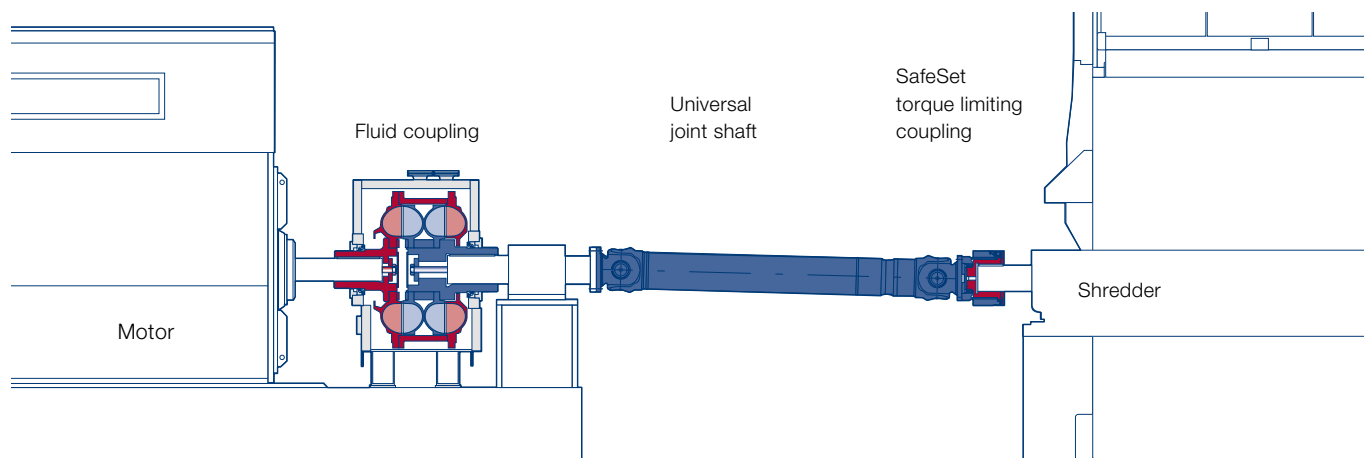

Fluid coupling



Universal joint shaft



Voith drive components

Advantages and benefits

Highly flexible coupling

- Reduces the risk of breakdowns on the shredder
- Shifts resonance frequencies into non-critical operating ranges
- Dampens critical torsional vibration amplitudes
- Effectively lowers torque peaks
- Increases the service life of the universal joint shaft in particular
- Can be easily integrated into the existing installation space during retrofitting
- No foundation needed

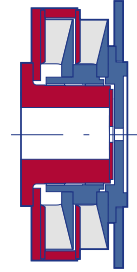

Fluid coupling

- Decouples motor and shredder mass moments of inertia, thereby shifting the resonance outside of the operating range
- Accelerates robust asynchronous squirrel-cage motors under no-load conditions
- Provides soft-start for large masses
- Dampens vibrations and torque peaks
- Limits torques to a safe level in the event of overload or blockage
- Uses the kinetic energy of the shredder rotor in the event of overload and limits the maximum motor current

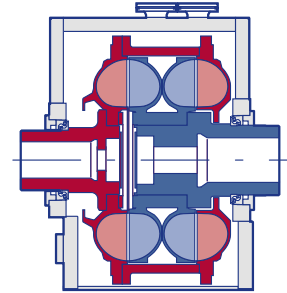

Universal joint shaft

- Transmits torques over large distances whilst still providing several degrees of axial, and radial misalignment
- Provides length compensation
- Avoids axial restraint
- Decouples motor and shredder in radial direction opposite to transverse acceleration



SafeSet torque limiting coupling

- Minimizes downtime by instant and accurate torque limitation in overload situations
- Protects driveline from costly repairs and make equipment operate safely at a maximum level

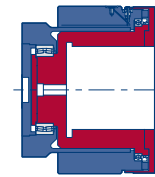

Voith services

Advantages and benefits

Diagnostics and condition monitoring

- For continuous monitoring, Voith provides a system for installation in shredder units
- The system can collect temperature, power and speed data, making it possible to analyze and optimize the unit
- The BTM Non-Contacting Thermal Measuring Device is a device used to measure coupling temperatures
- With remote data and the data logger, you can use the BTM to diagnose and prevent system-specific shutdowns, increase quality and thus have an effect on the entire operation
- This will reduce downtime, save money and provide transparency
- Easy to install or retrofit

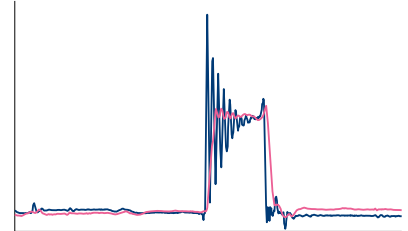

Service and engineering

- Calculation and design of the overall driveline properties
- Training courses, commissioning and completion of maintenance and repairs from a single source
- Negotiating warehouse programs to meet your needs
- Inspections, overhaul and repairs, on-site or in Voith workshops
- Spare parts and replacement machines with original quality
- Retrofitting and modernization for components from Voith or other manufacturers, also in combination with diagnostic services
- Engineering service for consultation on driveline problems
- Maintenance contracts customized to customers' needs; optimization of operational and maintenance concepts



Voith GmbH & Co. KGaA
St. Poeltener Str. 43
89522 Heidenheim, Germany

Contact Acida:
Phone +49 241 997392-0
www.acida.net

Contact Highly Flexible Couplings:
Phone +49 201 55783-61
highflex@voith.com

Contact Start-up Components:
Phone +49 7951 32-409
startup.components@voith.com

Contact Universal Joint Shafts and
Hirth Couplings:
Phone +49 7951 32-8283
UJShafts@voith.com

Contact Safeset:
Phone +46 650 540-150
sales.safeset@voith.com



VOITH
Inspiring Technology
for Generations