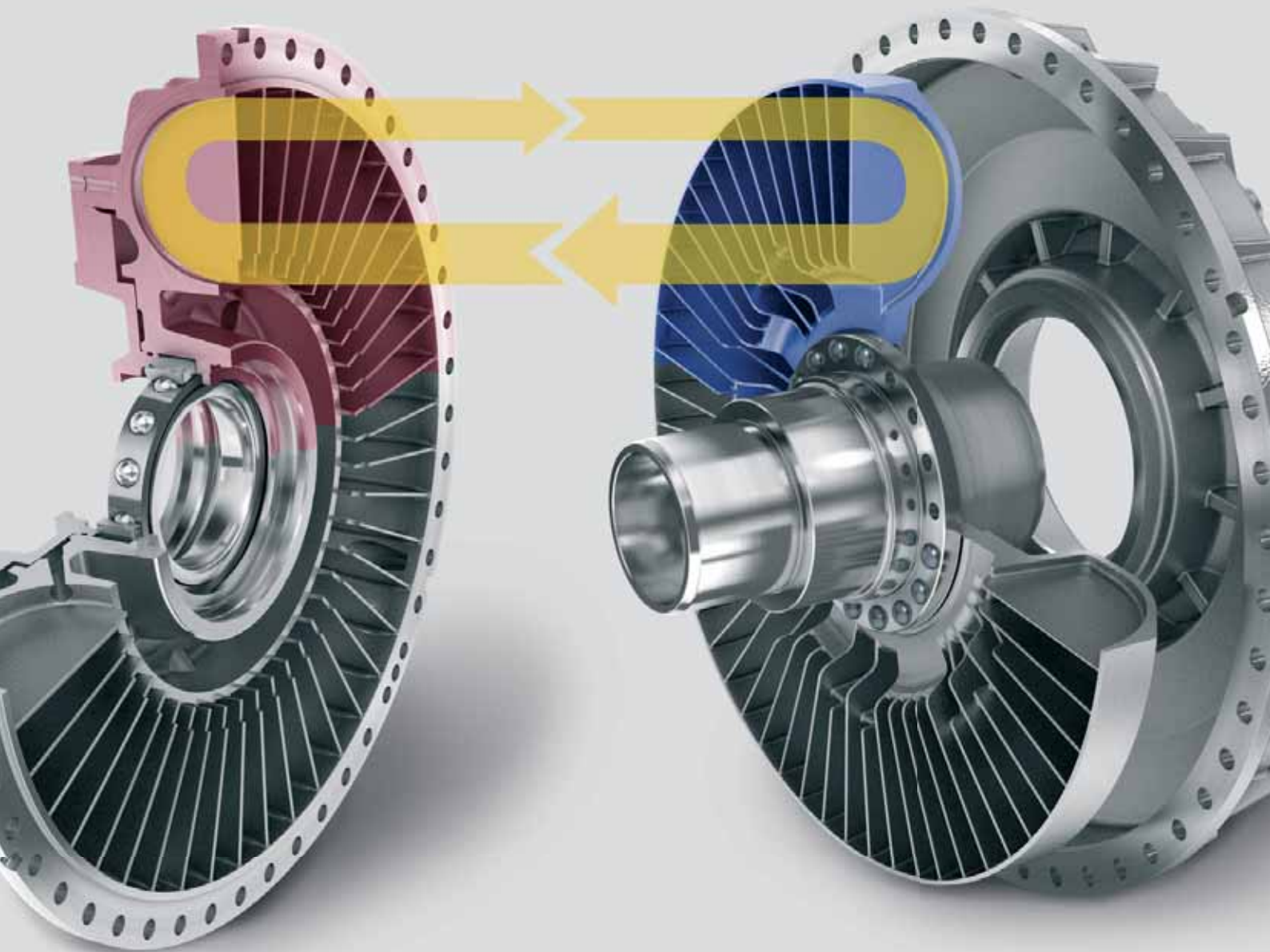


# Hydrodynamic Couplings

Principles | Features | Benefits





# Hydrodynamic Soft-start Couplings

Voith Turbo provides fluid coupling and drive solutions for the efficient and reliable operation of systems in the mining industry and the handling of raw materials. The hydrodynamic principle of a fluid coupling makes it possible to gently accelerate driven machines and to transfer power in a wear-free manner. At the same time, the fluid coupling protects the drive system to the maximum degree, even under extreme operating conditions, against damage and this reduces downtimes.

Voith Turbo, a Group Division of Voith GmbH, is a specialist for intelligent drive solutions and systems. Customers from highly diverse industries such as oil and gas, energy, mining and metal processing, ship technology, rail and commercial vehicles rely on advanced technologies from Voith Turbo.

Voith sets standards in the markets energy, oil & gas, paper, raw materials and transportation & automotive. Founded in 1867, Voith employs almost 39000 people, generates EUR 5.3 billion in sales, operates in about 50 countries around the world and is today one of the largest family-owned companies in Europe.

# Contents

1	Dawn of the hydrodynamic power transmission	4	5	The fluid coupling as soft-start and safety coupling	36
2	Drive systems	6	5.1	Fluid coupling with constant fill	37
2.1	The operating principles of hydrodynamic power transmission	7	5.1.1	Basic design features	38
2.2	Föttinger Units	9	5.1.2	Multifunctional type range	39
3	Hydrodynamic principles	10	5.1.3	Selection criteria and hydrodynamic features	42
3.1	Fluidic connections	10	5.2	Fill-controlled fluid couplings	44
3.2	Similarity laws for hydrodynamic power transmitters	12	5.2.1	Basic design features	44
3.2.1	Geometric similarity	12	5.2.2	Application-oriented type range	46
3.2.2	Similarity of flow velocities	13	5.2.3	Selection criteria and hydrodynamic features	46
3.2.3	Similarity of hydrodynamic power transmitters	14	5.3	Materials	48
3.3	Interaction of several flow machines	16	5.4	Operating fluids	48
3.3.1	Primary characteristic curves	17	5.4.1	Standard operating fluids	48
3.3.2	Secondary characteristic curves	17	5.4.2	Special operating fluids	50
3.4	Determining characteristic curves	20	5.4.3	Special design aspects of constant-fill couplings	51
4	Hydrodynamic couplings	21			
4.1	Characteristic curves	22			
4.2	Fluid couplings in drive systems	23			
4.2.1	Electric motor, multi-motor drives	24			
4.2.2	Diesel engine	27			
4.3	Dependence on rotation direction and direction of action	30			
4.4	Structure of the coupling designs	32			
4.4.1	Constant-fill couplings	34			
4.4.2	Variable-speed couplings	34			
4.4.3	Clutch couplings	34			
4.5	Hydrodynamic features, advantages and benefits	35			

## Formula symbols

The formula symbols used generally correspond to DIN 1304 or typical international use. To improve readability and ensure quick comprehension, there are additional explanations for some formula symbols at points.



Fig. 1: Prof. Hermann Föttinger  
(b. February 9, 1877 in Nuremberg [DE];  
d. April 28, 1945 in Berlin [DE])

# 1 Dawn of the Hydrodynamic Power Transmission

The development of hydrodynamic power transmission goes back to a basic patent filed by young electrical engineer Dr. Hermann Föttinger in the year 1905. As an employee of a shipyard (Stettiner Vulkan), it was his task to combine the quickly running steam turbine (drive machine) emerging in the ship- building industry with the slow running ship's propeller (driven machine). The steam turbine provided significantly improved efficiency compared with the directly coupled piston steam engine used up to that point. It was also more powerful and required less space.

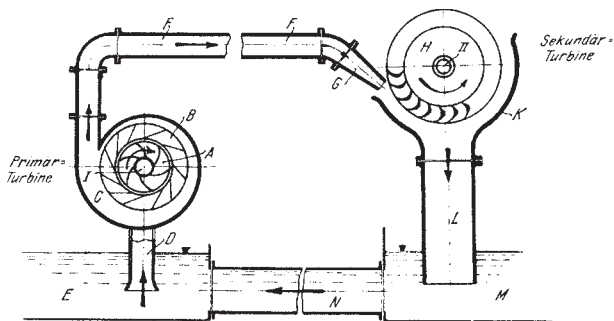
Essentially, Föttinger had to solve two problems:

1. Converting the torque ( $T$ ) and speed ( $\omega$ )
2. Reversing the direction of the propeller for forward / reverse travel

Föttinger's first idea was a direct conversion using a gear unit. This idea was quickly discarded because the gears at that time were only sufficiently resistant to a force of 500 HP.

**Fig. 2: Föttinger's sketch of the idea of hydrodynamic power conversion**

The pump and turbine are still physically separate.

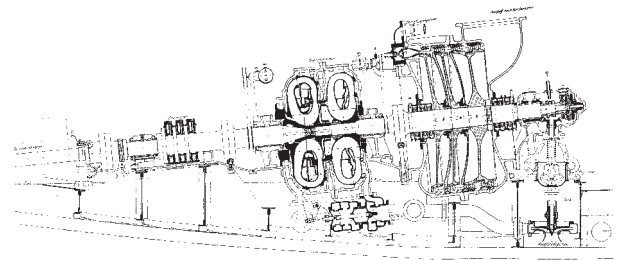


Another idea was indirect electrical conversion using a rotating differential transformer. However, the high-voltage equipment that would be required for this on-board and the large mass and considerable volume meant that this solution was not an option.

Systematic and purely theoretical problem-solving studies finally brought Föttinger to hydrodynamics. He developed the hydrodynamic torque converter (the Föttinger converter), a true feat of engineering that gave him an extremely efficient method of converting the power factors between the driving and driven machinery.

**Fig. 3: A cross-section of the drive system for the trial ship he built (constructed in 1909)**

From right to left: Steam turbine, converter for reverse travel, converter for forward travel, outgoing propeller shaft.



In recognition of his pioneering work in the field of hydrodynamics, Föttinger was offered a chair as professor of fluidics at the Technical University in Danzig in 1909, and at the Technical University in Berlin in 1924.

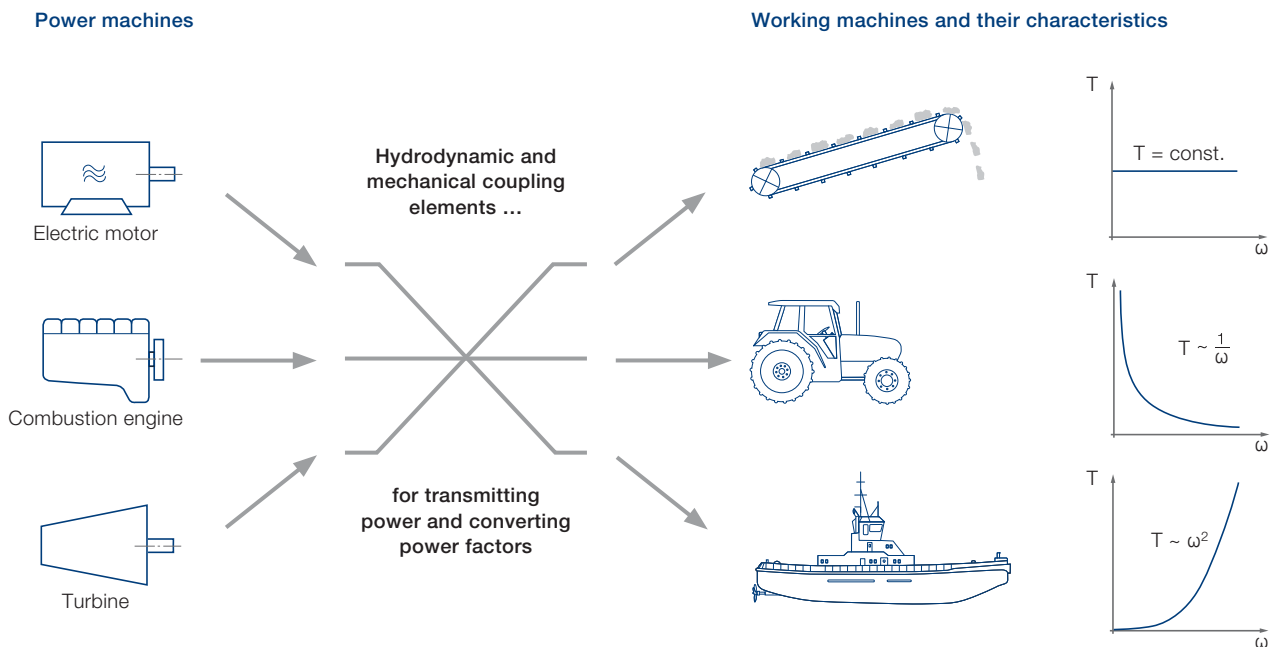
# 2 Drive Systems

The value of industrial drive systems increases with the value of the functions made available by the respective drive for the driven machine or process. It is therefore essential for the drive engineer to understand the driven processes and their requirements.

The same questions must be answered for today's drive and driven machinery as for those in use 100 years ago:

- Which drive system is required for the process?
- What kind of drive machinery can serve the process?
- What types of drive machinery are available?
- Which features of drive or driven machinery are not applicable to the process?
- What technical drive elements are suitable for adaptation?

Fig. 4: Power transmission elements combine the driving machine with the driven machine



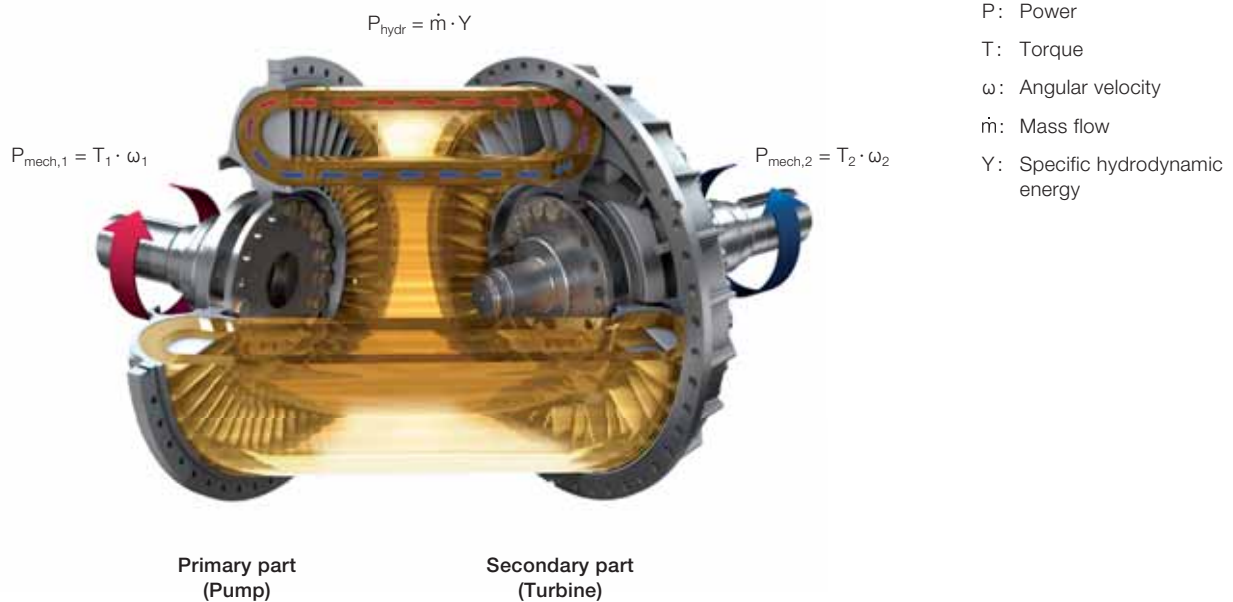
## 2.1 The Operating Principles of Hydrodynamic Power Transmission

Transmitting power from the driver to the driven machine occurs predominantly according to the **direct operating principle** in conventional machine construction, for example through shafts, mechanical couplings or gear units. Despite the great variety of gear units used to convert the torque and speed through gears, belt pulleys etc., their operating mechanisms all lead back to the lever or wedge.

Another advantage of the indirect torque transmission principle is the difference in transfer behavior between steady state and fluctuating torque conditions. Primary or secondary low-frequency torque fluctuations are severely dampened during the transfer; higher-frequency torque fluctuations are barely passed on at all. The inertia and friction behavior of the rotating fluid flow are the reasons for this characteristic.

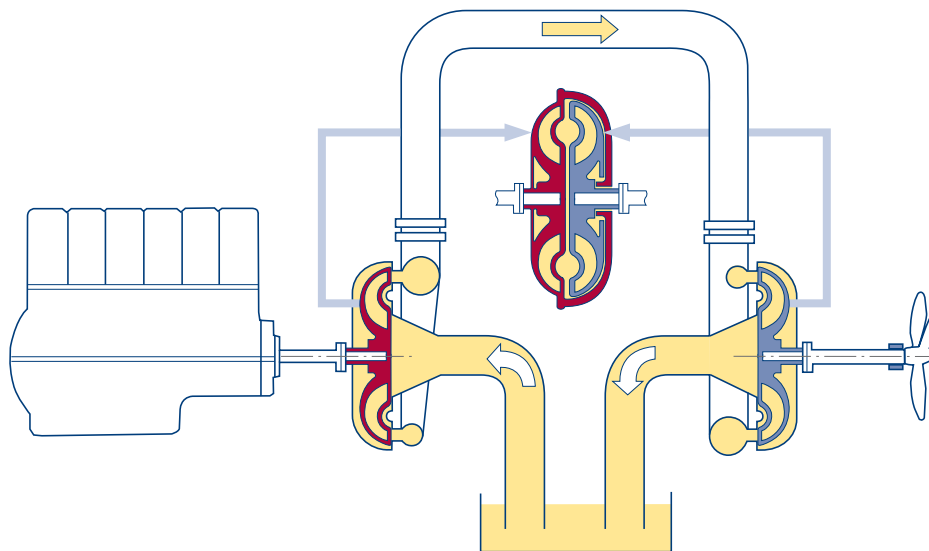
In contrast, hydrodynamic power transmission occurs based on an **indirect operating principle**. A primary part (pump wheel) transfers the introduced mechanical energy to kinetic energy in fluid flow. The higher energy fluid flows centrifrically from the pump wheel to the secondary part (turbine wheel), where a reconversion to mechanical energy (force) takes place. The power is transferred from the pump to the turbine without any contact, and thus without wear. Only the required bearing and sealing elements are subject to natural wear and tear.

Fig. 5: Power transmission and conversion according to the indirect operating principle



**Fig. 6: Principle of hydrodynamic power transmission**

The pump and turbine become one unit, a hydrodynamic coupling in this case



Hydrodynamic units contain primary and secondary-part flow machinery: a centrifugal pump and a turbine. The torque results from the directional flow change experienced by the rotating fluid in the respective vane wheels through deflection.

The vane wheels (pump impeller and turbine wheel) are arranged in an enclosed housing so that the fluid immediately flows through all wheels one after the other. The vane wheels do not come into contact with each other; only the fluid flow creates the torque transmission between the wheels. The turbine speed, or hydrodynamic slip, changes according to the load – a trait unique to hydrodynamic couplings. The pump impeller is connected to the primary driver, the turbine wheel to the driven machine.



## 2.2 Föttinger Units


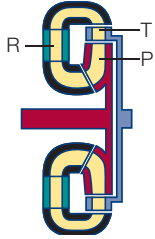





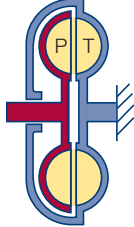

The method proposed by Föttinger for hydrodynamic power transmission led to three units:

- Hydrodynamic torque converter (converter)
- Hydrodynamic coupling (turbo coupling, flow coupling, fluid coupling)
- Hydrodynamic brake (retarder, flow brake)

In honor of Hermann Föttinger as their inventor, hydrodynamic power transmitters are also referred to as “Föttinger Units.”

The torque converter is the basic unit, with the coupling and brake being special cases. Directive VDI 2153 establishes the terms, designations, versions, principles of operation and calculation methods used.

### Basic elements and main features of the Föttinger Units

Föttinger Unit	Basic elements	Description	Schematic representation	Main features
Converter		Hydrodynamic torque converters have at least three vane wheels (main parts) that redirect the flow: the pump, turbine and reaction member, also called a guide wheel.		 $T_P + T_T + T_R = 0$ $\omega_P \geq \omega_T$ or $\omega_P < \omega_T$
Coupling		Hydrodynamic couplings have two vane wheels as main parts: the pump and turbine, which together with a shell form the working chamber.		 $ T_P  =  T_T $ $\omega_P > \omega_T$
Brake		Hydrodynamic brakes have one rotating and one fixed vane wheel: the pump (rotor) that is connected to the drive shaft, and the turbine (stator) that is connected to the housing.		 $ T_P  =  T_T $ $\omega_T = 0$

P: Pump,  
T: Turbine,  
R: Reaction member (guide wheel)

# 3 Hydrodynamic Principles

## 3.1 Fluidic Connections

Processes in hydrodynamic machines and installations can be described using the relationships of fluidics. The most important physical parameters are the speed, pressure, density and viscosity of flowing media. The media can be fluid or gaseous. Hydrodynamic power transmitters actually only use fluids, since only they offer a sufficiently high density. Daniel Bernoulli and Leonhard Euler laid the foundations of fluidics in the 18th century. Building on **Bernoulli's energy equation**

$$g \cdot h + \frac{p}{\rho} + \frac{1}{2} \cdot c^2 = Y = \text{const.}$$

Euler developed **Euler's equation for turbomachinery** from the principle of linear momentum (Newton's second law):

$$Y = \Delta(r \cdot c_u) \cdot \omega = \Delta(u \cdot c_u) = (r_2 \cdot c_{u2} - r_1 \cdot c_{u1}) \cdot \omega \\ = u_2 \cdot c_{u2} - u_1 \cdot c_{u1}$$

Bernoulli's energy equation states that, in a stationary and friction-free flow, the sum of the energy forms "height, pressure and speed" remains constant. Height and pressure energy play only a subordinate role in flow machinery. It is the change of flow speed in both amount and direction between the inlet and outlet of the vane wheel that determines the torque at the machine shaft.

**Euler's turbine equation** describes these circumstances:

$$T = \dot{m} \cdot (r_2 \cdot c_{u2} - r_1 \cdot c_{u1})$$

From this, the transferred power can be calculated:

$$P = T \cdot \omega = \dot{m} \cdot (r_2 \cdot c_{u2} - r_1 \cdot c_{u1}) \cdot \omega = \dot{m} \cdot Y,$$

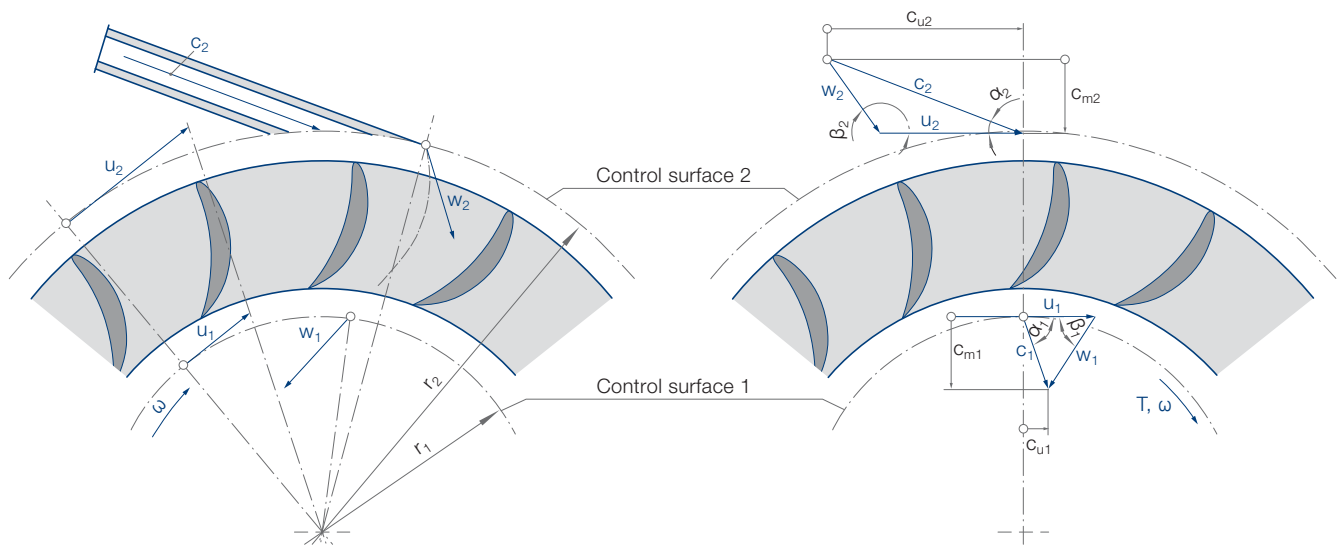
where  $Y$  is the specific hydrodynamic energy. In flow machinery,  $Y$  is designated as the enthalpy.



- 1 Daniel Bernoulli  
(b. February 8, 1700 in Groningen [NL]  
d. March 17, 1782 in Basel [CH])
- 2 Leonhard Euler  
(b. April 15, 1707 in Basel [CH]  
d. September 18, 1783 in St. Petersburg [RU])

**Fig. 7: Principle sketch clarifying Euler's turbine equation**

The spin change is the difference ( $r_2 \cdot c_{u2} - r_1 \cdot c_{u1}$ )



c: Absolute velocity  
u: Circumferential velocity  
w: Relative velocity

Indices legend:  
2: Inlet  
1: Outlet  
u: Circumferential component  
m: Meridian component

## 3.2 Similarity Laws for Hydrodynamic Power Transmitters

Describing the torque characteristic of a hydrodynamic power transmitter using Euler's turbine equation has proven to be too awkward in practice. The similitude and model laws for flow machinery provide a simplified representation that is more useful for practical situations.

### 3.2.1 Geometric similarity

Geometric similarity is an indispensable prerequisite to be able to compare (test) models with real machines from smaller or larger series.

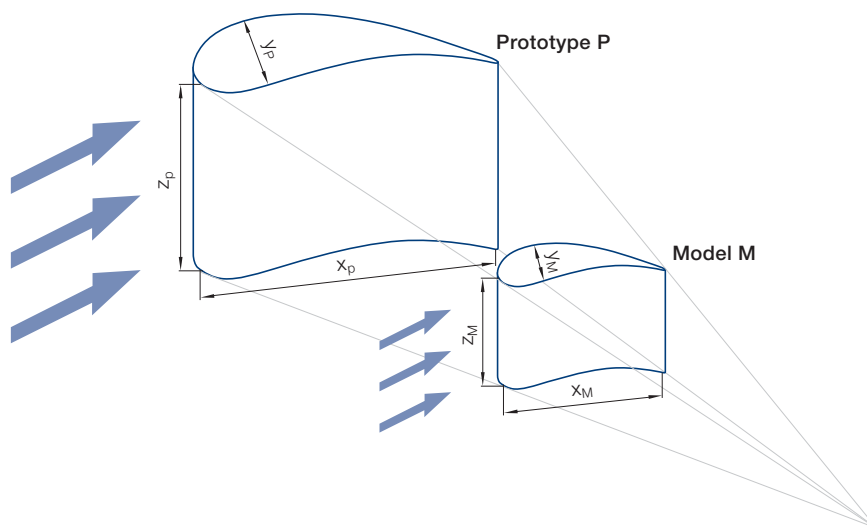
If there is geometric similarity, the following applies to all measurements in the three dimensions:

$$\frac{x_M}{x_P} = \frac{y_M}{y_P} = \frac{z_M}{z_P} = k = \text{const.},$$

where  $k$  is the scaling factor.

Transferred to flow machinery, this means that the same scale is applied to the geometry in all three directions in space.

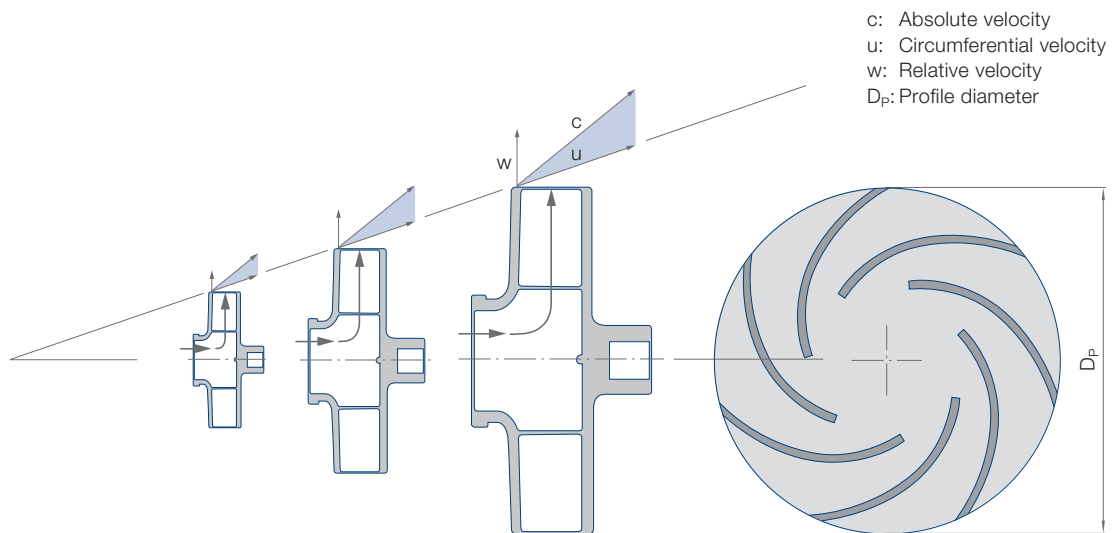
Fig. 8: Same length ratios, this means geometrically similar models



### 3.2.2 Similarity of flow velocities

The similarity of flow velocities is given where the velocity triangle is similar at analogous positions; this means their respective angles are the same or the size ratio of the respective sides is the same.

Fig. 9: Geometric similarity and similarity of flow velocities using pump impellers as an example



### 3.2.3 Similarity of hydrodynamic power transmitters

Euler's turbine equation

$$T = \dot{m} \cdot (r_2 \cdot c_{u2} - r_1 \cdot c_{u1})$$

$$= \rho \cdot \dot{V} \cdot (r_2 \cdot c_{u2} - r_1 \cdot c_{u1})$$

contains geometric parameters (radii and flow surfaces), velocities and media density.

In addition to geometric similarity, complete application of the similarity and model laws requires similarity of fluid-element flow velocities at analogous positions for both model and reality.

Thus, the following similarity relationships for hydrodynamic power transmitters apply.

#### Similarity laws for hydrodynamic power transmitters

Basic parameters of the hydrodynamic power transmitter	Designation	Similarity relationship
Length, radius, material thickness	l, r, s	~ D
Surfaces, cross-sections	A	~ D <sup>2</sup>
Volumes, masses	V, m	~ D <sup>3</sup>
Velocities	c, u, w, v	~ ω · D

The similarity laws for hydrodynamic power transmitters are essentially fulfilled if the Euler number Eu and Reynolds number Re (see table below) from the similarity theory of fluidics for models and real machines are the same.

#### Dimensionless characteristics of fluidics

Characteristic	Calculation	Relative strength
Euler number	$Eu = \frac{p}{\rho \cdot v^2}$	$\frac{\text{Compressive force}}{\text{Inertia force}}$
Reynolds number	$Re = \frac{v \cdot l}{\nu}$	$\frac{\text{Inertia force}}{\text{Frictional force}}$

If you insert the similarity relationships into Euler's turbine equation, the following results:

$$T_P \sim \rho \cdot D_P^5 \cdot \omega_P^2 \quad \text{with}$$

- $T_P$ : Hydrodynamic torque of the pump
- $\rho$ : Density of the operating fluid
- $D_P$ : Profile diameter of the pump impeller, largest radial vane profile extension of the pump (possible deviating definition for torque converters)
- $\omega_P$ : Angular velocity of the pump impeller

The proportionality factor is a dimensionless characteristic that directive VDI 2153 stipulates as binding for Föttinger Units and describes as the  $\lambda$  power coefficient.  $\lambda$  describes the level of power take-up for geometrically and fluidically similar converters, couplings and brakes (same Euler and Reynolds number) and considers design, fill level and other features. As such, the following equations apply to torque and power:

$$T_P = \lambda \cdot \rho \cdot D_P^5 \cdot \omega_P^2,$$

$$P_P = T_P \cdot \omega_P = \lambda \cdot \rho \cdot D_P^5 \cdot \omega_P^3$$

For other flow machines, for example pumps, turbines or fans, a proportionality factor can be derived from Euler's turbine equation in the same manner.

The following model laws for hydrodynamic power transmitters are useful for practical situations:

### Generally valid model laws for flow machines

Meaning	Equation	Model law	Proportionality factor	Use
Flow pressure	$Eu = \text{const.}$	$p \sim \rho \cdot D^2 \cdot \omega^2$	1	Calculation of pressures
Flow force	$F = \int p \cdot dA$	$F \sim \rho \cdot D^4 \cdot \omega^2$	Axial force factor $\delta$ (Voith-internal)	Calculation of axial thrust
Volume flow	$\dot{V} = A \cdot c$	$\dot{V} \sim D^3 \cdot \omega$	Specific volume flow $q$ (Voith-internal)	Calculation of fluid flows for changing fill level and cooling
Mass flow	$\dot{m} = \rho \cdot \dot{V}$	$\dot{m} \sim \rho \cdot D^3 \cdot \omega$	Specific volume flow $q$ (Voith-internal)	Calculation of fluid flows for changing fill level and cooling
Torque	$T = F \cdot r$	$T \sim \rho \cdot D^5 \cdot \omega^2$	Power coefficient $\lambda$ (VDI 2153)	Calculation of torque transmission
Power	$P = T \cdot \omega$	$P \sim \rho \cdot D^5 \cdot \omega^3$	Power coefficient $\lambda$ (VDI 2153)	Calculation of power transmission

## 3.3 Interaction of Several Flow Machines

In Föttinger Units, at least two flow machines work together (pump and turbine). The two wheels are exclusively coupled by flow forces (hydrodynamic torque transmission). The turbine speed is independently and continuously adjusted according to the load. This is a feature unique to hydrodynamic couplings.

In drive technology, dimensionless ratio values are used to describe this special characteristic:

### Dimensionless characteristics for flow machines

Characteristic	Relationship
Speed ratio	$v = \frac{\omega_T}{\omega_P} = \frac{n_T}{n_P} = 1 - s$
Slip <sup>1</sup>	$s = \frac{\omega_P - \omega_T}{\omega_P} = \frac{n_P - n_T}{n_P} = 1 - v$
Conversion (torque ratio)	$\mu = \left  \frac{T_T}{T_P} \right $
Efficiency (power ratio)	$\eta = \frac{P_T}{P_P} = \frac{T_T \cdot \omega_T}{T_P \cdot \omega_P} = \mu \cdot v$

<sup>1</sup> The slip is typically given as a %:  $s = s \cdot 100\%$

$\omega_P$ : Pump angle velocity  
 $\omega_T$ : Turbine angle velocity

$n_P$ : Pump speed  
 $n_T$ : Turbine speed

$T_P$ : Pump torque  
 $T_T$ : Turbine torque

$P_P$ : Pump power  
 $P_T$ : Turbine power

The dependence of the transmitted torque on the speed ratio  $v$  is characterized as the “**first characteristic relationship**” of the Föttinger Units. Naturally, the power coefficient  $\lambda$  for Föttinger Units is not a constant, but rather dependent on the speed ratio  $v$ :

$$\lambda = f(v)$$

In addition to the speed ratio, there are other parameters influencing the power coefficient: the layout and function of the vane wheels, the filling level of the Föttinger Unit and other design features.



### 3.3.1 Primary characteristic curves

A **primary characteristic curve** describes the dependence of the pump torque  $T_P$  on the pump speed  $n_P$  (drive speed, primary speed) at constant speed ratio  $v$ . Due to the laws of similarity, the primary characteristic curves represent parabolas that are indicated by a  $\lambda$ -value. For other speed ratios, other  $\lambda$ -values apply, and thus other parabolas. This set of curves results in the “**primary characteristic curves.**” In practice, the primary characteristic curves are also called slip parabolas.

$$T_P \sim n_P^2 \Big|_{\lambda, v = \text{const.}}$$

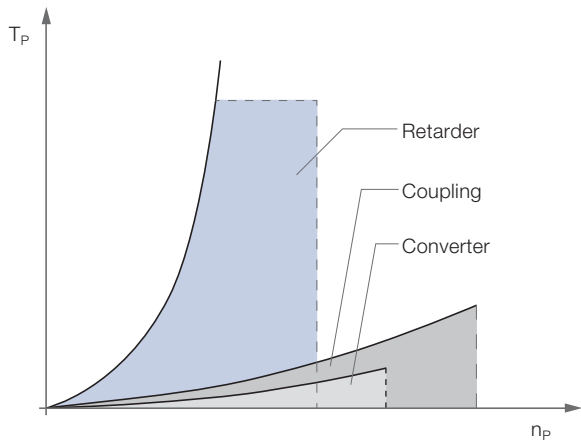
### 3.3.2 Secondary characteristic curves

A **secondary characteristic curve** (frequently just called a **characteristic curve**) describes the dependence of the power coefficient  $\lambda$  on the speed ratio  $v$  with a constant drive speed  $n_P$  for torque converters and couplings. This dependence is called the “first characteristic relationship” (see 3.3) or the characteristic curve of the Föttinger Units.

$$\lambda = \frac{T_P}{\rho \cdot D_P^5 \cdot \omega_P^2} = f(v) \Big|_{n_P, \omega_P = \text{const.}}$$

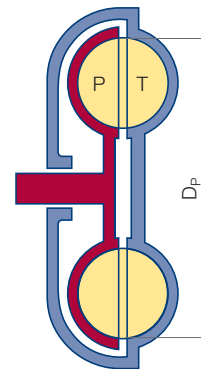
$$\lambda \sim T_P$$

Fig. 10: Primary characteristic curves

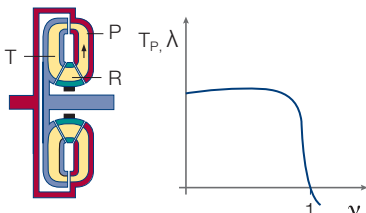
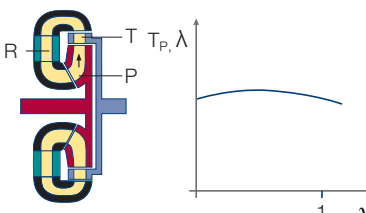
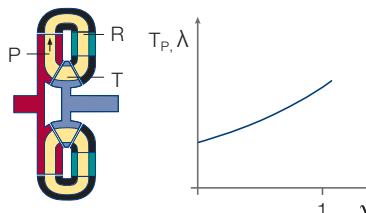




Primary characteristic curves of the three Föttinger Units of the same size with typical design limits on the power coefficient  $\lambda$  and maximum pump speeds, related to the same profile diameter.

Fig. 11: Sketch of the profile diameter  $D_P$



Secondary characteristic curves for various designs of torque converters and couplings

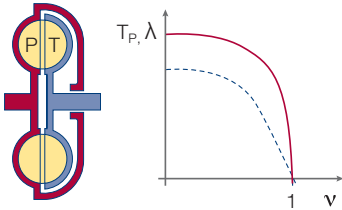
	Trilok converter	Föttinger converter (Lysholm converter)	Counter-rotation converter (DIWA converter)
Design and characteristic curve			
Typical properties		$T_P + T_T + T_R = 0, \mu = \left  \frac{T_T}{T_P} \right $	
Course of characteristic curve	Deviating at $v \approx 1$ , Zero crossing at $v = 1$	Almost constant	Increasing
Turbine feature	Centripetal throughflow	Centrifugal throughflow	Axial throughflow
Throughflow sequence			
Housing feature	Rotating	Fixed	Fixed

The course of a secondary characteristic curve, the course of the pump torque with increasing turbine speed at constant pump speed, is strongly dependent on the throughflow of the turbine in the circuit. In the case of a turbine with centripetal throughflow (from the outside inward, applying to all couplings and to Trilok converters depending on their function), the pressure drop between pump and turbine falls as the turbine speed increases. This reduces the circumferential mass flow required for transporting energy. Where  $v=1$  the drop in pressure is zero; the secondary characteristic curve has a zero crossing.

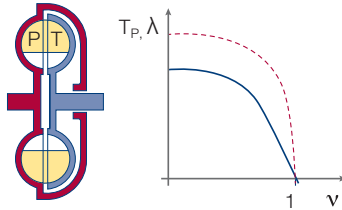
The classic Föttinger converter with centrifugal throughflow turbine (from the inside outward) behaves differently. Here the turbine hardly has any effect on the power take-up of the pump. Axial throughflow converter turbines like the counter-rotation converter increase the capacity of the pump through increasing turbine speeds – essentially, it is fed.

**Secondary characteristic curves** (frequently just referred to as **characteristic curves**) result from changes to regulating variables such as guide vane position, throttle opening and filling that influence the spinning of the fluid elements and/or the circumferential mass flow. This makes it possible to transfer different torques at the same turbine speed  $n_T$  (secondary speed).

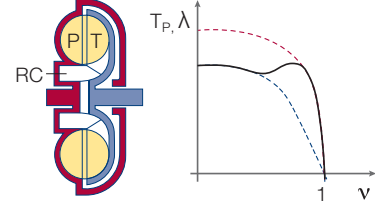
Fluid coupling completely filled



Fluid coupling partially filled



Fluid coupling with retaining capacity RC completely filled



$$|T_P| = |T_T|, \quad \mu = \left| \frac{T_T}{T_P} \right| = 1$$

Steadily falling

Self-formative  
The unvaned retaining capacity RC takes on part of the operating fluid when turbine speeds are low

Centripetal throughflow



Rotating

**Converters** are almost exclusively operated completely filled. This requires a fill pressure (superimposing pressure) that prevents flow separations, and thus cavitation. Adjustable guide vanes (reaction member) create the secondary characteristic curves by changing the spin and mass flow.

**Couplings** are operated completely filled or partially filled. Conducting or carrying off operating fluid while at a standstill or during operation changes the circumferential mass flow and creates the secondary characteristic curves.

### 3.4 Determining Characteristic Curves

The mathematical development of characteristic curves for hydrodynamic power transmitters has come a long way. Louis Henri Navier and George Gabriel Stokes laid the groundwork for this at the end of the 19th century. They described a transient, frictional flow field using a differential equation that can only be solved analytically in very simple cases.

The one-dimensional streamline flow theory provides a simplified approach to calculating characteristic curves. It enables the principle course of characteristic curves to be described in the case of completely filled Föttinger Units. This calculation approach is rarely suitable for partially filled units, especially couplings.

In the 1970s, it became possible to describe the transient flow spectrum through suitable statistical turbulence models. This provided the breakthrough for numeric solution methods for the Navier-Stoke differential equation. The advances in computer technology with increasingly powerful computers now permit an efficient and true-to-reality simulation of flow problems. This process is known as “computational fluid dynamics” or CFD for short, and is today a fixed component in the development and design process of Föttinger Units. The scope of the model attempts to determine characteristic curves is thus considerably reduced.

A final model or prototype test confirms the hydrodynamic design data and properties (characteristic curves). The power coefficient  $\lambda$  is calculated from the measured power factors.

Fig. 12: Methods of fluidics

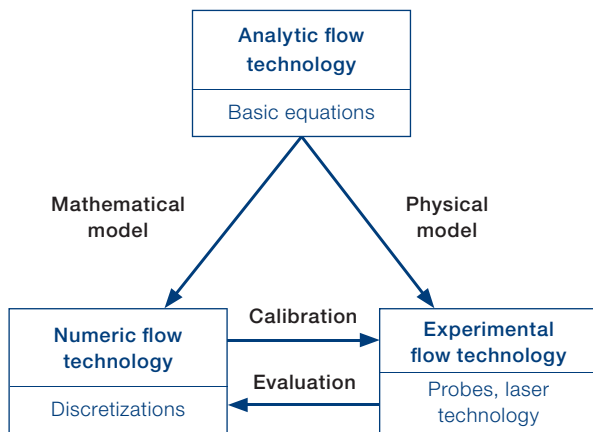
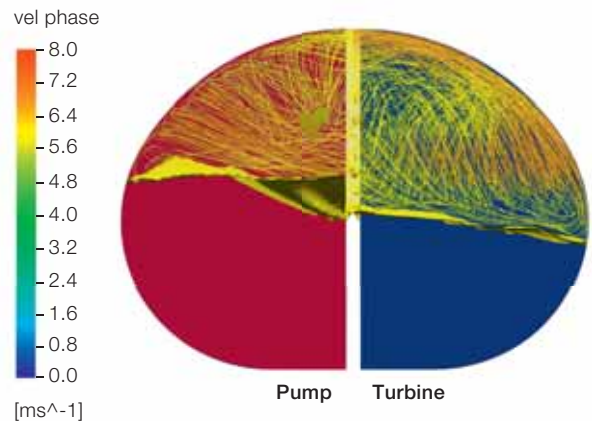


Fig. 13: CFD simulation of a partially filled fluid coupling



# 4 Hydrodynamic Couplings

Hydrodynamic couplings only contain two circumferential vane wheels (pump impeller and turbine wheel), frequently called the primary and secondary wheel in practice. Ignoring minimal loss moments from air friction or sealing elements, the hydrodynamic torques at both pump and turbine are the same. The operating fluid flows from the pump directly into the turbine and from the turbine back into the pump; there are no further elements on which a torque can be supported.

The following equations apply to **couplings**:

$$|T_P| = |T_T|,$$

$$\mu = \left| \frac{T_T}{T_P} \right| = 1,$$

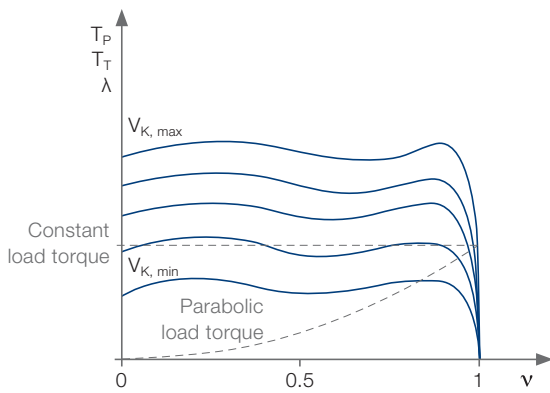
$$\eta = \frac{P_T}{P_P} = \frac{T_T \cdot \omega_T}{T_P \cdot \omega_P} = \mu \cdot v = v \quad \text{and}$$

$$\lambda = \frac{T_P}{\rho \cdot D_P^5 \cdot \omega_P^2} \quad \text{where } \lambda \sim T_P, T_T |_{\omega_P = \text{const.}}$$

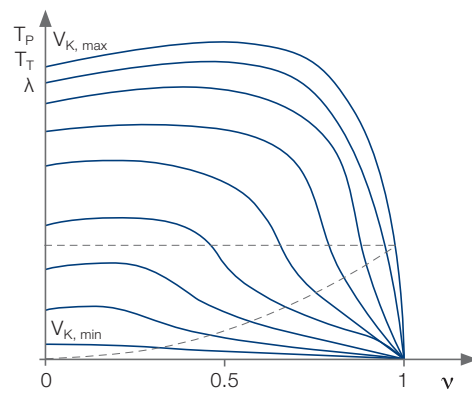
Fig. 14: 3-D sectioned model of a hydrodynamic constant-fill coupling with fluid distribution during start-up



**Fig. 15: Secondary characteristic curves of a soft-start and safety coupling**



**Fig. 16: Secondary characteristic curves of a variable-speed coupling and clutch coupling**



## 4.1 Characteristic Curves

The characteristic relationship  $\lambda = f(v)$  in the form of a characteristic curve describes the transfer behavior of the coupling at constant drive speed (see 3.3.2). A set of characteristic curves results from the **fill level**  $V_K$  as a parameter, referred to as the (secondary) characteristic curves of a hydrodynamic coupling.

The characteristic curve basic form for hydrodynamic couplings has a strictly monotone falling course (see tables on page 18/19). The size selection corresponds to the featured principle of turbine speed adjustment so that the required rated torque  $\lambda_{\text{N}}$  is transferred with the lowest possible rated slip. Additional drive requirements determine the type of coupling and the associated course of the characteristic curve.

For **soft-start and safety couplings** that are constantly filled, a characteristic curve as horizontal as possible over the entire start-up range is usually best. This developed characteristic curve course provides driven machines with constant load torque (e.g. belt conveyors) for a near-constant acceleration torque and good limitation of maximum torque ( $\lambda_{\text{max}}$ ).

For **variable-speed couplings and clutch couplings**, where the filling level actively changes during operation, steadily falling characteristic curves with a wide range are desirable. This results in stable operating points with drive speed control/adjustment, for both driven machines with parabolic load torque and driven machines with constant load torque.



- 1 Voith fluid coupling in a belt conveyor drive
- 2 Voith fluid coupling in a bucket-wheel excavator drive

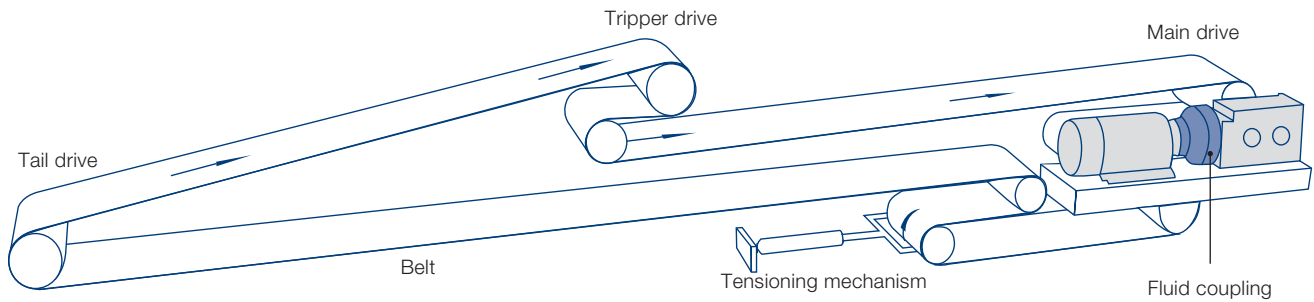
## 4.2 Fluid Couplings in Drive Systems

The complete description of drive systems with hydrodynamic couplings requires the view of the behavior with changing drive speed  $n_p = f(t)$ . Variable drive speeds are especially present during the start-up process. A load-dependent pressing of the drive motor or system-dependent speed fluctuations also cause variable drive speeds.

The load-dependent, independent setting of turbine speed (see 3.3) and the dependence of the transferrable torque from the square of the drive speed (see 3.3.1) leads to noteworthy advantages for the drive system (see 4.5).

The behavior with variable drive speed is of special significance for couplings with constant fill, since active change of the fill level during operation is not possible.

Fig. 17: Belt conveyor with hydrodynamic constant-fill coupling in the drives



#### 4.2.1 Electric motor, multi-motor drives

The squirrel cage asynchronous (induction) motor is the most widely distributed electric motor today, especially in stationary drive technology. The main reasons for this are the low acquisition costs, low maintenance and the robust quality of the machine itself.

A disadvantage of the squirrel cage asynchronous motor is the high starting current. After connecting the stator voltage, a starting current flows when the motor is at a standstill that is 5 to 9 times the rated current, depending on the type of motor. This high starting current causes a drop in voltage, especially with weak power supply systems, which leads to a drop in motor torque in the end (proportional to the square of the voltage drop). In individual cases, a total failure of the power supply is even possible.

A fluid coupling in the drive chain relieves the motor significantly during run-up, because the transferrable torque (coupling torque) increases as a square function of the drive speed. The motor quickly runs through the high-current range, so the effects of voltage drops on the drive system are minimal.

With multi-motor drives and weak power supplies, it is easily possible to have time-delayed activation of the individual motors to protect the power supply. The fluid couplings in the first drives to be activated slip until the total system torque required to break free is achieved.



**Fig. 18: Drive process of a loaded belt conveyor with hydrodynamic constant-fill coupling (type TVV) in the drive**

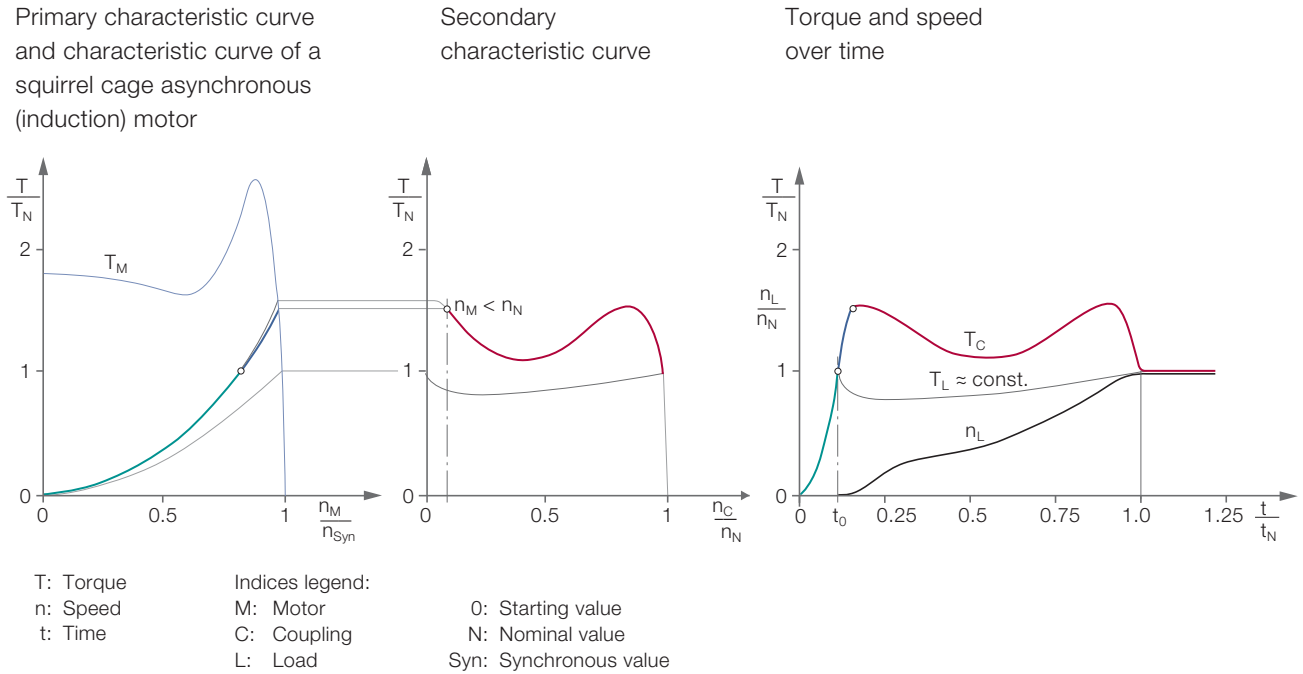


Fig. 18 describes the start-up process of a typical belt conveyor with hydrodynamic constant-fill coupling in the drives.

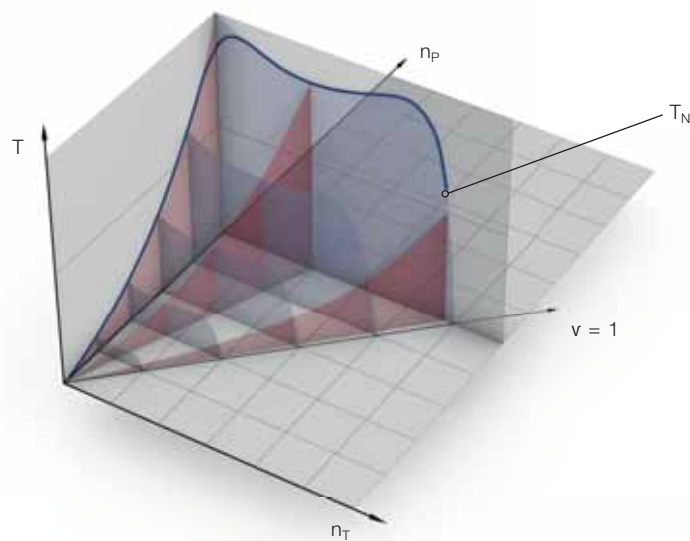
**Green:** The hydrodynamic coupling largely decouples the start-up process of the asynchronous electric motor and belt conveyor. Up to point in time  $t_0$ , a coupling moment  $T_C$  (turbine torque) builds up that increases parabolically with the motor speed  $n_M$ . The belt conveyor begins to move once the coupling torque  $T_C$  has exceeded the load torque  $T_L$ . At this point in time, the motor has not yet reached its final speed.

**Blue:** The coupling torque is also dependent on the speed ratio  $v$  with further increasing motor speed according to the secondary characteristic curve.

**Red:** After ending the motor run-up, the coupling torque corresponds to the secondary characteristic curve. The fluid coupling limits the introduced torque in the conveyor very efficiently. The conveyor gently accelerates to its rated speed due to the excessive torque.

**Fig. 19: Start-up of a belt conveyor drive with asynchronous electric motor and fluid coupling;**

the load torque is virtually constant



The characteristics necessary for calculating the start-up can be clearly presented in figure 19. They are taken from the primary and secondary characteristic curves.



United States Coast Guard Cutter (USCGC) Bertholf with two Voith fluid couplings in the CODAG (Combined Diesel and Gas) drive.

#### 4.2.2 Diesel engine

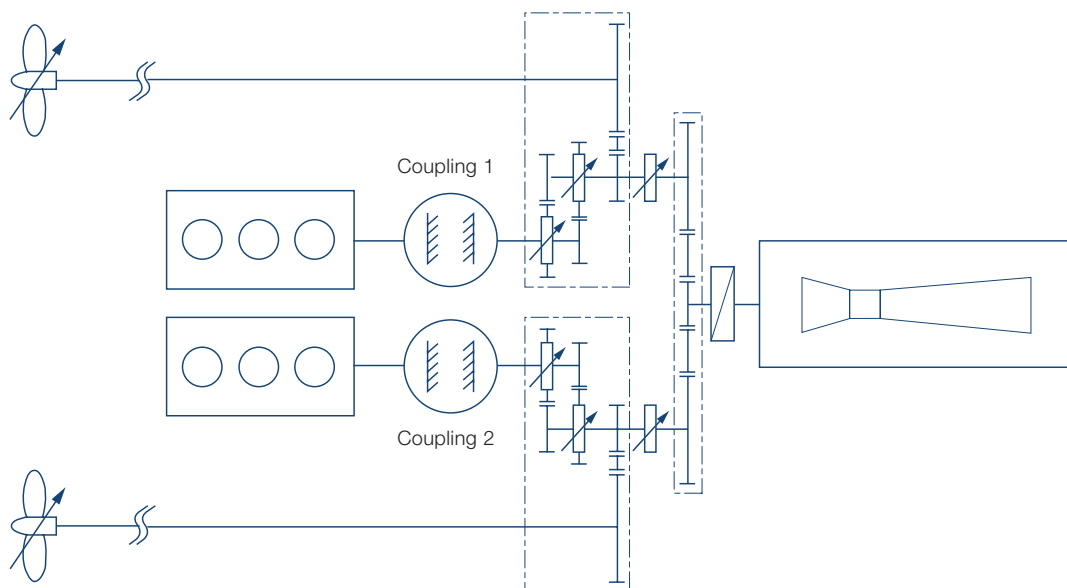
The diesel engine is an internal combustion engine that is very popular, particularly in marine applications. This type of engine exhibits good efficiency even when under partial load. Its great operational safety and reliability, together with a long service life, make it extremely attractive as a drive engine for marine vessels.

Low-speed 2-stroke engines with speeds of up to 250 rpm are used in very large ships such as tankers and container ships. Low-speed engines are directly connected to the ship propellers using shafts. Medium-sized ships, for example, passenger ships or military vessels, commonly use medium-speed 4-stroke engines at speeds up to 1 350 rpm. Sport and

leisure boats and those used for inland water transport frequently make use of high-speed 4-stroke engines with speeds of up to 2 000 rpm. Transmissions that reduce speed are down stream of the medium-speed and high-speed engines. Today, marine diesel engines are usually equipped with exhaust gas turbochargers.

One disadvantage of a diesel engine with a turbocharger is the lack of power at low speeds. This lack of power is known as turbo lag. Other negative characteristics are the excitation of torsional vibrations in the drive train and the danger of engine stalling when overloaded.

Fig. 20: Drive train of the USCGC Bertholf with two diesel engines (2 x 7 400 kW) and one gas turbine (1 x 22 000 kW)



Integrating a hydrodynamic coupling into the driveline is particularly beneficial if one or more of the following drive-system requirements exist: damping of torsional vibrations, limitation of torque spikes, shifting of resonance frequencies, automatic load sharing for multi-engine drives and rapid disconnection of one diesel engine from the rest of the drive train. In theory, these requirements exist only for medium-speed and high-speed marine diesel engines.

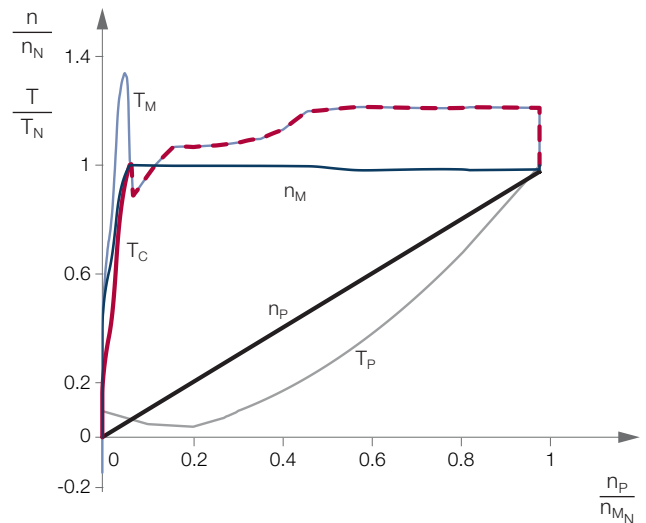
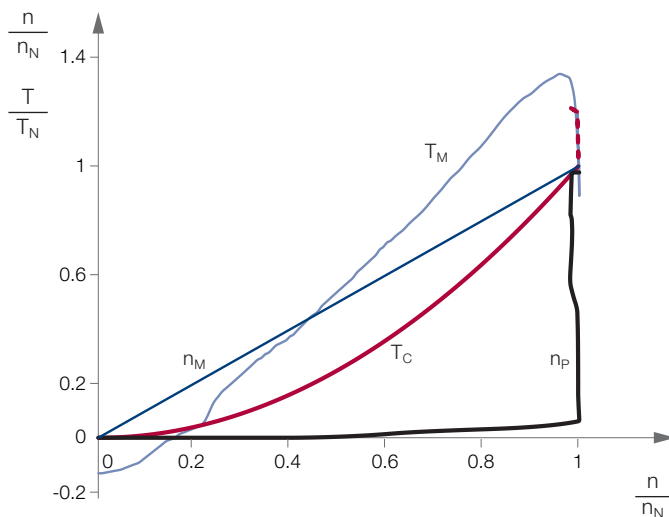
The fluid coupling is always located in the drive train between the engine and the transmission. When starting, it decouples the engine from the large moments of inertia on the secondary side because of the coupling's primary characteristic curve ( $T_P \sim n_P^2$ ). Consequently, the engine starts and will accelerate essentially load-free. In addition, hydrodynamic ship couplings have a specially developed (dynamic) primary characteristic curve that avoids engine operating points where turbo lag is present.

The hydrodynamic fluid coupling dampens torsional vibrations throughout the entire drive train. Its low torsional rigidity can usually permit shifting the first natural frequency of the system to below the idle speed of the engine. In addition, the fluid coupling protects the transmission and downstream components against torsional vibrations originating in the diesel engine. Similarly, torsional vibration excitations and torque spikes introduced into the driveline from the load side by the propeller are effectively dampened.

**Fig. 21: Typical starting process of a ship diesel engine with a Type TP fill-controlled fluid coupling in the drive**

Primary characteristic curve and characteristic curve of a ship diesel engine.

Secondary characteristic curve and load characteristic curve of a ship propeller.



Meaning of the indices:  
 T: Torque  
 n: Speed  
 t: Time  
 M: Motor  
 C: Coupling  
 P: Propeller  
 N: Nominal value

The damping behavior of the fluid coupling provides a number of advantages for the ship propulsion system. These have a positive effect on the total cost of ownership as well as the safety and comfort of passengers and cargo on board.

Lower stress on the drive components increases their availability and reduces wear in the drive system. This yields longer maintenance intervals and a longer service life for the entire drive. This is particularly important for ships whose operation requires frequent, fast changes in speed or that are exposed to pronounced changes in waterway conditions. For ships that have a risk of the propeller blocking, for example ice breakers, the fluid coupling provides an effective overload protection that prevents secondary damage.

Lower torsional vibration amplitudes and shock loads in the drive system also result in noticeably lower noise emissions.

The automatic load sharing provided by the fluid coupling due to its secondary characteristic curve, is a useful feature for CODAD (Combined Diesel and Diesel) and CODAG (Combined Diesel and Gas) drive systems.

A switching function of the coupling, desirable with CODAD and CODOG (Combined Diesel or Gas) drives, can easily be implemented with fill-controlled fluid couplings (see 4.4).

Torque and speed curves versus time.

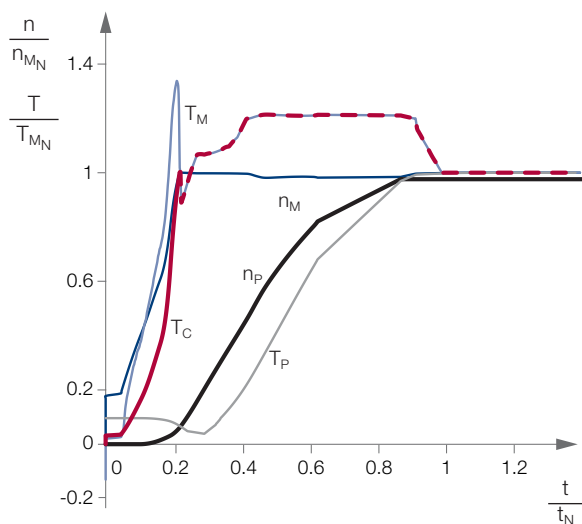
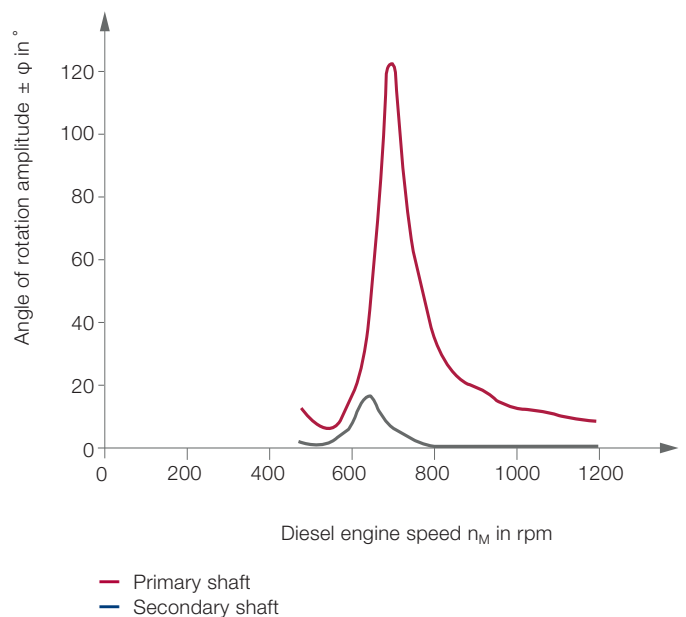


Fig. 22: Damping function of the hydrodynamic coupling

The hydrodynamic coupling dampens torsional vibration and torque spikes in the drive train. It shifts resonance frequencies at the same time.



# 4.3 Dependence on Rotation Direction and Direction of Action

The preceding chapters describe the power transmission from pump impeller to turbine wheel in a specific rotation direction. However, various applications demand a view of the transmission behavior with reversal of the rotation direction and/or reversal of the direction of the power flow. In the latter case, the function of the vane wheels changes; the primary wheel takes on the function of the turbine and the secondary wheel the function of the pump.

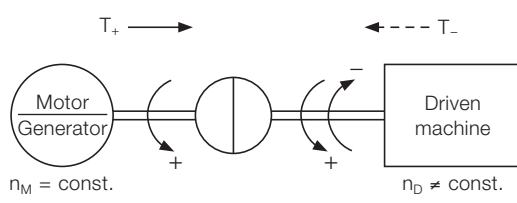
An expansion of the secondary characteristic curves to four quadrants includes all conceivable operating conditions. Fig. 23 only shows the characteristic curves for an established rotation direction of the (electric) motor/generator to ensure a better overview. By mirroring the characteristic curves at the origin of the coordinate system, the characteristic curve course for the other rotation direction of the motor/generator results.

The 1st and 2nd quadrants describe the power flow from the primary to the secondary wheel with different rotation directions of the driven machine. In the 4th quadrant, the power flows from the driven machine to the motor/generator in the same rotation direction. The speed of the driven machine is higher than that of the generator.

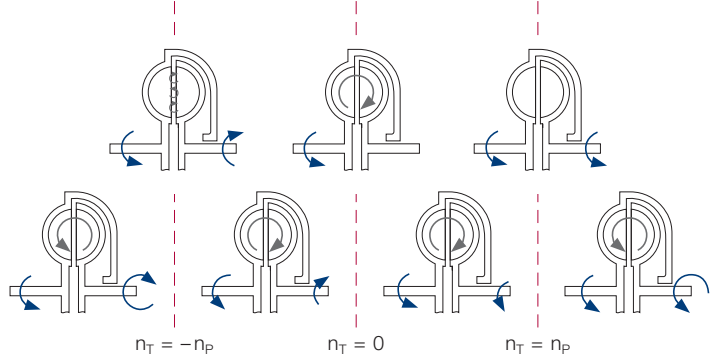
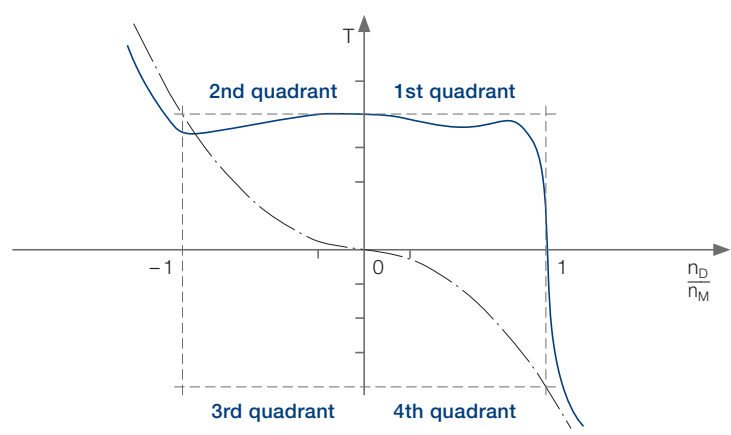
The symmetrical design of the vane wheels and the hydrodynamic principle ensure the function for many coupling designs, regardless of the drive rotation direction. Most of the applications are limited to the operation in the 1st quadrant of the characteristic curves. The behavior in the remaining quadrants is of significance for special events or with special work processes.

**Fig. 23: Stable characteristic curve course over three quadrants of the operating characteristic curves,**

presented for three rated speeds and one rotation direction of the drive motor



- T: Torque
  - n: Speed
- Meaning of the Indices:
- M: Motor/Generator
  - D: Driven machine
  - P: Pump
  - T: Turbine
  - +: Power flow Motor → Driven machine
  - : Power flow Driven machine → Generator



The stable characteristic curve course in the 2nd quadrant allows, for example for marine propulsion, controlled braking of the propeller and turning of the propeller rotation direction. The horizontal torque course around zero speed provides the opportunity, among other things, for a soft coil and tensioning mechanism for cables. The steep transition from 1st to the 4th quadrant enables a seamless change from motor to generator operation for electric motor drives. Such behavior is beneficial for belt conveyors partially or completely conveying downward, for example.

For standard designs, constructive solutions of pumps and other components can bind the operation to specific quadrants.

The pump impeller and turbine wheel for soft start and safety couplings generally have an asymmetric design (table on pag-

es 18-19). This means there are different characteristic curve courses when there is a change in the power flow direction. However, the transitions from the 1st to the 4th quadrant and vice versa are constant. One special design is a coupling with vanes diagonal to the axle, also referred to as “inclined bladed wheels” (Fig. 24). This coupling variant has a distinct free-wheel action.

In marine propulsion where two diesel engines drive a propeller via a double gear unit, this behavior is particularly useful (Fig. 25): If, for example, engine 2 with  $n_2$  drives the output side of coupling 1 faster than  $n_1$  via the gear unit, then engine 1 only has minimal drag torque – even with a fully filled coupling. For variable-speed couplings and clutch couplings with coupling discharge, it is even possible to virtually decouple engine 1 from the traction of the drive. Afterwards, engine 1 can be shut down with no further action required.

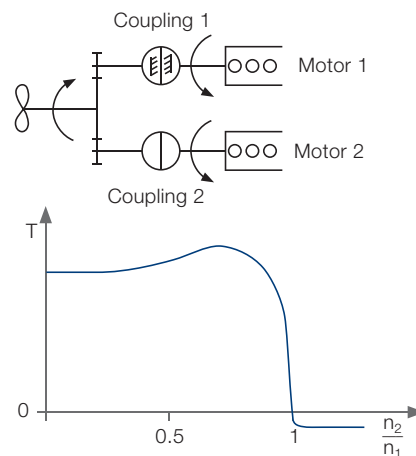
**Fig. 24: Coupling wheels**

with straight and diagonal vanes



**Fig. 25: Marine propulsion with two diesel motors;**

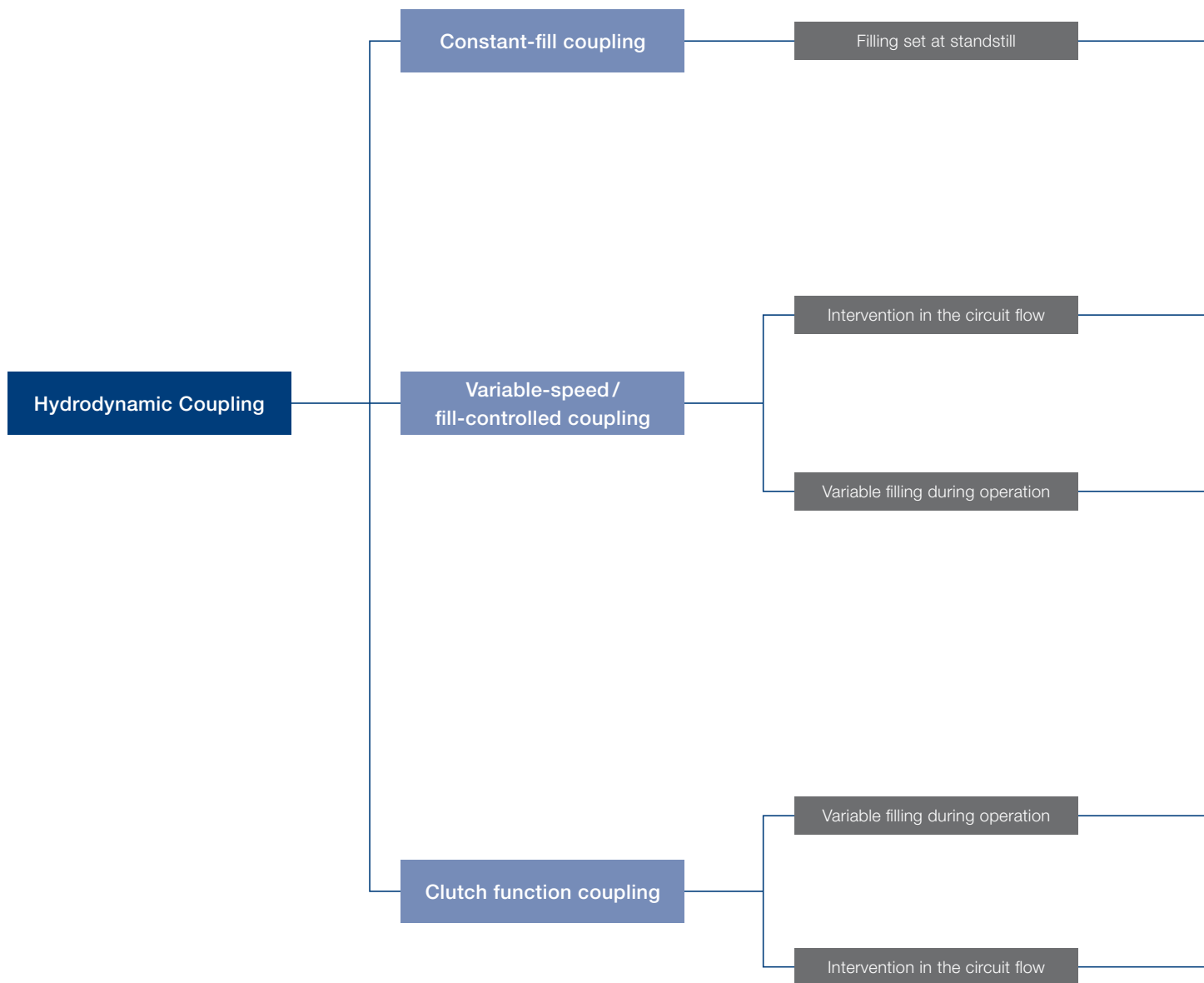
the hydrodynamic coupling with diagonal vanes has good free-wheel action



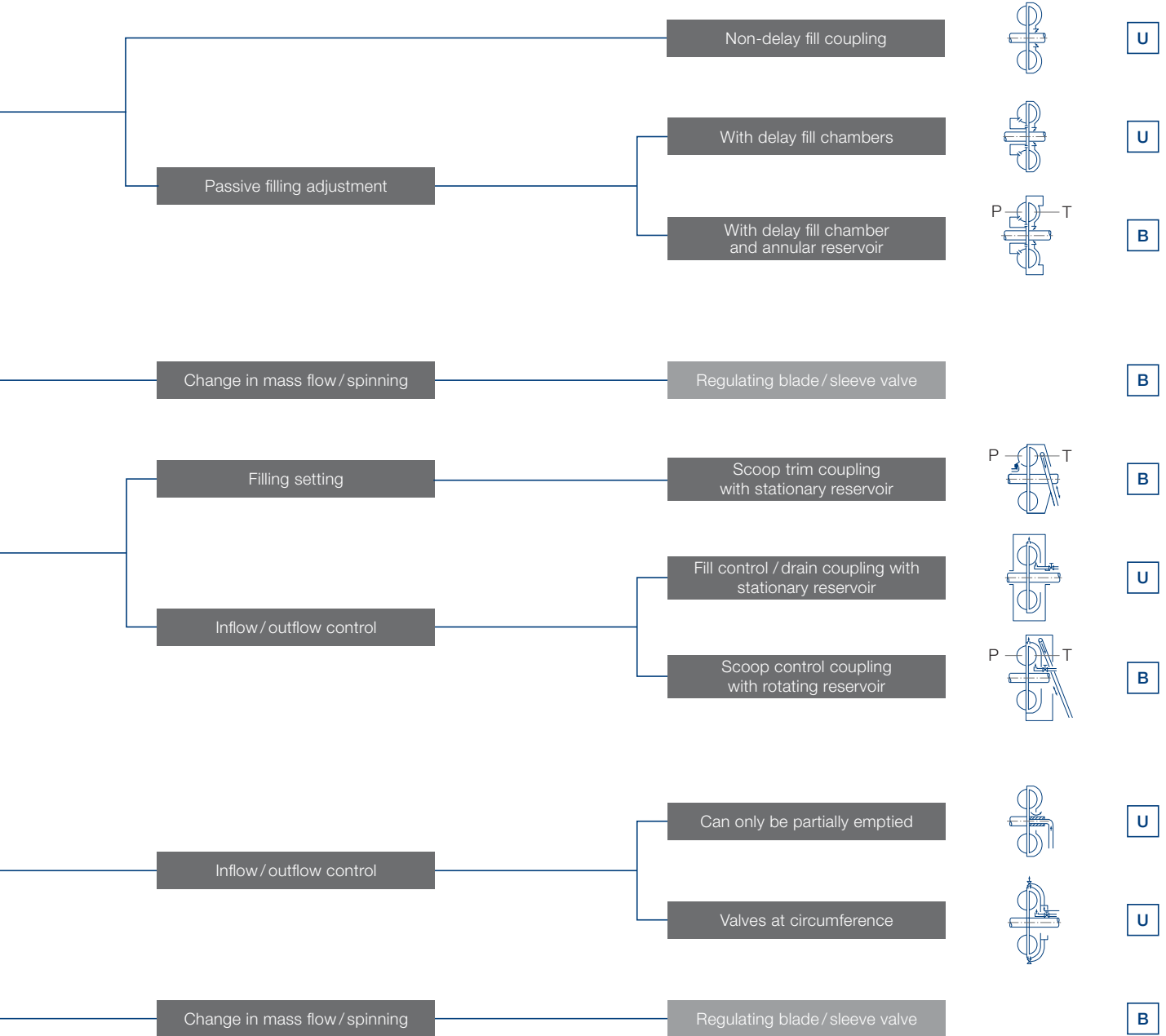
## 4.4 Structure of the Coupling Designs

Fig. 26: Structure of the designs of hydrodynamic couplings

according to directive VDI 2153 – according to the terminology of the shaft couplings







#### 4.4.1 Constant-fill couplings

Couplings of this design are mainly used for start-up, to limit torque and to influence the torsional vibration behavior of the drive chain.

The designs mainly differ through adjoining chambers, whose automatically controlled filling and emptying have a significant influence on the start-up behavior.

Constant-fill couplings are sealed to the outside. Filling first occurs before commissioning. Drive requirements determine the design and filling quantity. The ratio of the operating fluid volume filled to the overall volume of the coupling is called the fill level. The coupling obtains a specific characteristic curve from the fill level (see 4.1). Manually adding or removing operating fluid (at a standstill) enables subsequent characteristic curve adaptations.

#### 4.4.2 Variable-speed couplings

Variable-speed couplings control or regulate the speed of the driven machine over a wide range below the drive speed. Stable operating points are set for the most important driven machine characteristic curves.

Variable-speed couplings have devices that seamlessly change the transmission behavior during operation. This mainly occurs by changing the fill level. Variable-speed couplings always have an external fluid circuit for filling changes that can also aid cooling.

The fill level can be changed during operation either via a radially movable scoop tube or by controlling the operating fluid inlet and outlet via valves and nozzles.

#### 4.4.3 Clutch couplings

Clutch couplings simply interrupt the traction between the drive motor and driven machine by removing the operating fluid.

Clutch couplings have devices that change the transmission behavior during operation between two limit values (usually the maximum and minimum fill level). The known design principles for variable-speed couplings are particularly applied to clutch couplings.

## 4.5 Hydrodynamic Features, Advantages and Benefits

Hydrodynamic couplings influence the power flow in a drive system in several ways through their operating principle. The required transmission features for torque and power as well as the influence on the entire system behavior are what determine the selection of a coupling in principle.

These transmission features are of significance for constant-fill couplings in particular, as they are at one with the operating principle with no external control intervention.

The following table compiles the most important hydrodynamic features of constant-fill couplings and indicates the resulting advantages and benefits for the entire system:

### Advantages and benefits of Voith Turbo fluid couplings in the drive chain

Hydrodynamic feature	Advantages, benefits
The coupling – and not the driven machine – determines the power output of the drive motor to the drive system	<ul style="list-style-type: none"> <li>+ Load-free motor run-up</li> <li>+ Gentle acceleration of the driven machine</li> <li>+ No motor oversizing</li> <li>+ Use of cost-effective standard motors</li> </ul>
The coupling limits the maximum torque occurring in the drive chain in relation to speed	<ul style="list-style-type: none"> <li>+ Overload and blocking protection</li> <li>+ No oversizing of drive components</li> <li>+ No drive-related oversizing of the driven machine</li> <li>+ Protection and longer service life for all system components</li> </ul>
System separation between the input and output side of the coupling, traction through flow of fluid	<ul style="list-style-type: none"> <li>+ Wear-free transmission of power</li> <li>+ Minimum maintenance and repair costs</li> <li>+ For multi-motor drives:               <ul style="list-style-type: none"> <li>– Time-delayed activation of motors to reduce load</li> <li>– Improved load sharing</li> </ul> </li> </ul>
Damping and/or separation of torsional vibrations and torque peaks <sup>1</sup>	<ul style="list-style-type: none"> <li>+ Improved dynamic features for the drive system and the system as a whole</li> <li>+ Protection and longer service life for all system components</li> </ul>
<b>For constant-fill couplings only:</b> Simple setting of transmission behavior by manually adding or removing operating fluid (at a standstill)	<ul style="list-style-type: none"> <li>+ Subsequent operating adaptations are possible</li> <li>+ Adjustable load sharing for multi-motor drives and no load oscillation</li> </ul>
<b>For variable-speed couplings only:</b> Simple setting of transmission behavior by controlled adding or removing of operating fluid (during operation)	<ul style="list-style-type: none"> <li>+ Control or regulation of start-up and operating process, adapted to the application</li> <li>+ Controllable load sharing with multi-motor drives</li> <li>+ Controlled emptying to interrupt the power flow in the drive chain</li> </ul>
<b>For clutch couplings only:</b> Simple setting of transmission behavior by controlled adding or removing of operating fluid (during operation)	<ul style="list-style-type: none"> <li>+ Controlled switching of power flow in the drive chain</li> </ul>

<sup>1</sup> Primary or secondary low-frequency torque fluctuations are severely dampened during the transfer; higher-frequency torque fluctuations are barely passed on at all (see 2.1). This positive feature for the system can be described from a physical-mathematical perspective (Kelvin model).

The sum of advantages and benefits that the hydrodynamic power transmission simultaneously provides is unique. No other technology is able to offer this with such low expense and such simplicity!

# 5 The Fluid Coupling as a Soft-start and Safety Coupling

Splitting the coupling designs in accordance with functional viewpoints in line with VDI 2153 into constant-fill couplings, variable-speed couplings and clutch couplings has not occurred in practice. Drive engineers generally prefer an application-oriented division into **soft-start and safety couplings** and **variable-speed couplings**.

Starting up drive systems and protecting the drive train against overload can in most cases be realized with constant-fill couplings. For more complex drive requirements, multiple fill-controlled couplings are used.

Fill-controlled coupling  
in a belt conveyor drive



## 5.1 Fluid Coupling With Constant Fill

Constant-fill fluid couplings are predominantly delivered “installation-ready” without operating fluid. Filling occurs at a standstill before commissioning. The requirements for start-up and transmission behavior determine the filling quantity (see 4.1).



Fig. 27: 3-D section model of a fluid coupling with constant fill (with operating fluid)

### 5.1.1 Basic design features

The Voith Turbo fluid coupling in its simplest form (type T) consists of just a few main components without additional adjoining storage chambers. Together with the shell, the vaned outer wheel forms the working chamber that is housed relative to the hub and sealed outside. The inner part consists of the hub and the inner wheel, which are fixed together. To offset minimal assembly imprecision, a connection coupling is required in the shaft line in coaxial arrangement.

The constructive design of this basic format does not yet establish the function of the vaned wheels as pump or turbine. The functional establishment occurs through clear assembly instructions or through various bores of the hubs on the driving and output ends. The designation of the vaned wheels is neutral and selected according to their position: inner wheel and outer wheel.

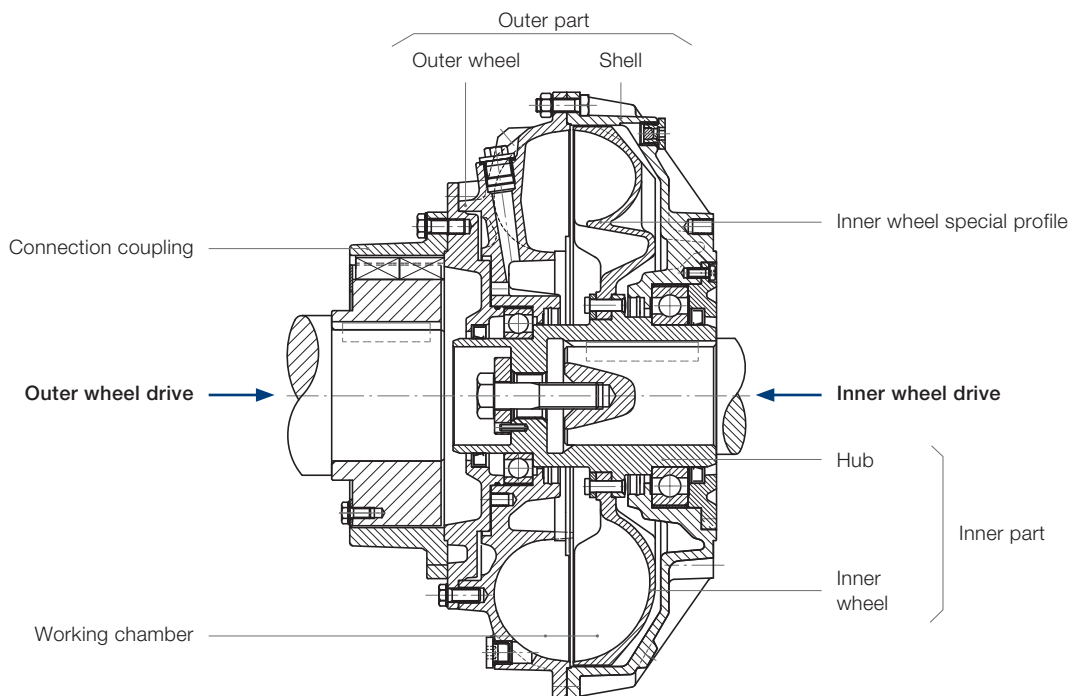
The power transmission is ensured with both installation variants,

1. Drive via outer wheel: **outer wheel drive** and
2. Drive via inner wheel: **inner wheel drive**.

However, dependent on the profile form, different characteristic curve courses form. Specially developed wheel profiles, mainly for inner wheels, lead to specific characteristic curves determined by the requirements. The coupling design establishes the type of drive (inner/outer wheel drive). A subsequent change requires a new check, especially with regard to torque limitation and heat dissipation.

**Fig. 28: Basic design of all fluid couplings with constant fill or coaxial installation,**

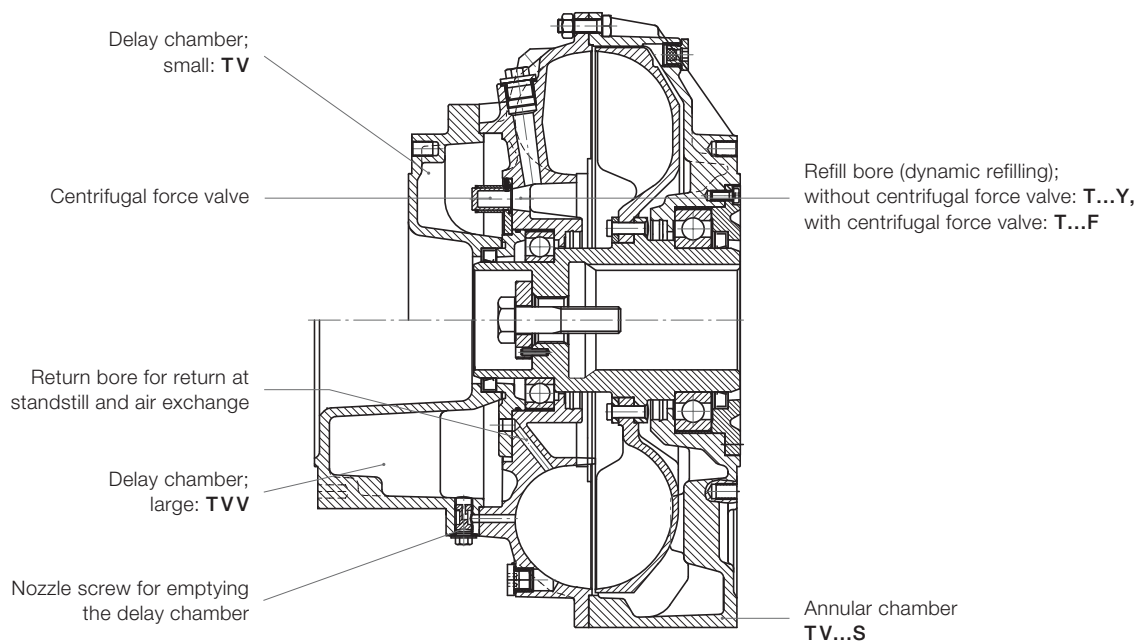
Type T fluid coupling with elastic connection coupling



### 5.1.2 Multifunctional type range

Voith Turbo has drawn on decades of experience to develop a multifunctional, modular type range for constant-filled fluid couplings. It is based on few main components and control features. This modular concept can fulfill a variety of requirements for the start-up and operating behavior as needed. The use of adjoining chambers and the volume exchange capability via fixed bores or bores closed with centrifugal force valves enable a great variation of characteristic curves in relation to speed, time and slip.

Fig. 29: Design features for achieving a multifunctional type range

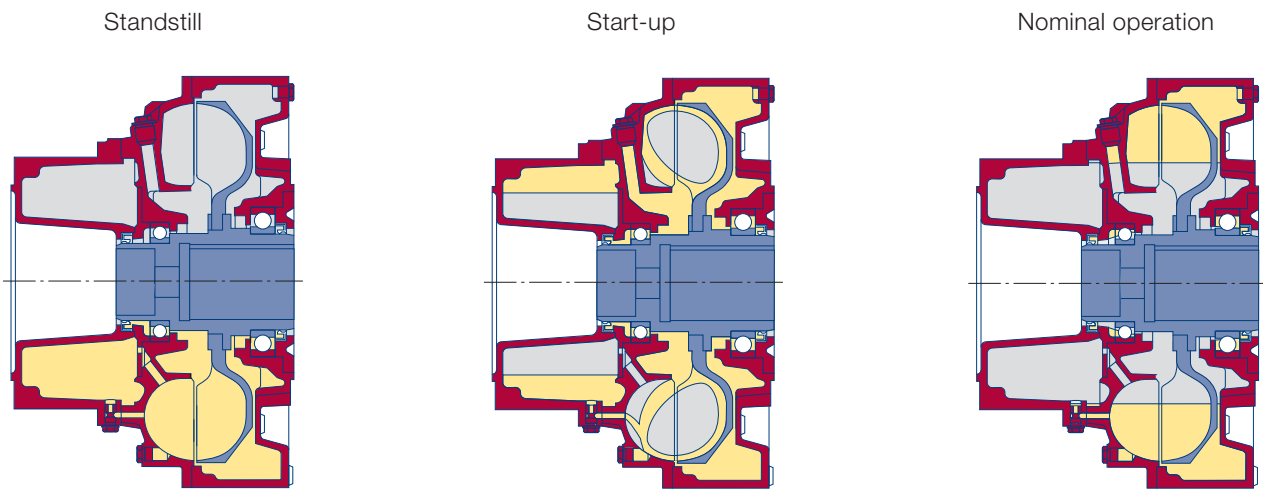


## Design features for achieving a multifunctional type range

Voith type designation	Design features	Function description
<b>T</b>	Basic design	The working chamber filling determines the start-up and operating behavior.
<b>TV</b>	Normal delay chamber	The delay chamber takes in part of the operating fluid at a standstill.
<b>TVV</b>	Enlarged delay chamber	During start-up, the delay chamber empties into the working chamber via nozzle bores.
<b>TV...S</b>	Delay chamber and annular chamber	<p>The delay chamber and annular chamber take in part of the operating fluid at a standstill.</p> <p>During motor run-up, the annular chamber also takes part of the operating fluid from the working chamber.</p> <p>During start-up, the delay chamber empties into the working chamber via nozzle bores.</p>
<b>TV...Y</b>	Delay chamber and refill bores	<p>The delay chamber takes in part of the operating fluid at a standstill.</p> <p>During motor run-up and at high slip, the working chamber partially empties into the delay chamber via the refill bores.</p> <p>With decreasing slip (increasing driven machine speed), the refilling process comes to a standstill. The delay chamber empties into the working chamber via nozzle bores.</p>
<b>TV...F</b>	Delay chamber and centrifugal force valves	<p>The delay chamber takes in part of the operating fluid at a standstill.</p> <p>During motor run-up and at high slip, the delay chamber continues to fill with operating fluid from the working chamber via the refill bores if the centrifugal force valves are open.</p> <p>Shortly before reaching motor rated speed (upper switching speed), the centrifugal force valves close and the refilling process comes to a stop. The delay chamber empties into the working chamber via nozzle bores.</p> <p>If weak power supplies have voltage drops with motor pressing, the centrifugal force valves open at a lower switch speed. The working chamber partially empties into the delay chamber via the refill bores. The load on the motor is relieved and it runs up again.</p> <p>This cyclic operation is repeated until the power supply is stabilized or a thermal fuse in the system responds.</p>

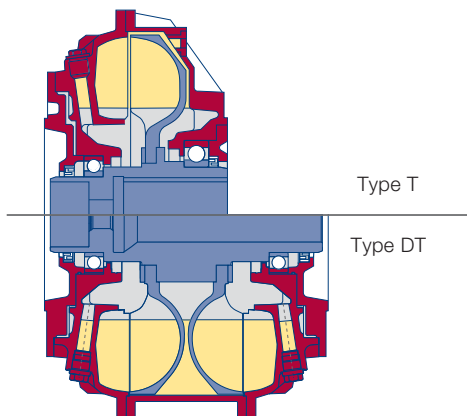


**Fig. 30: Distribution of the operating fluid in a type TVVS fluid coupling**



A further element of the modular type range is the double circuit coupling version (Fig. 31, type DT). The two flow circuits of a DT coupling are switched parallel in principle. This enables double the power transmission with the same outer diameter. Function characteristics vary only insignificantly.

**Fig. 31: Comparison of single and double circuit coupling (T/DT)**



### 5.1.3 Selection criteria and hydrodynamic features

#### Power characteristic curves

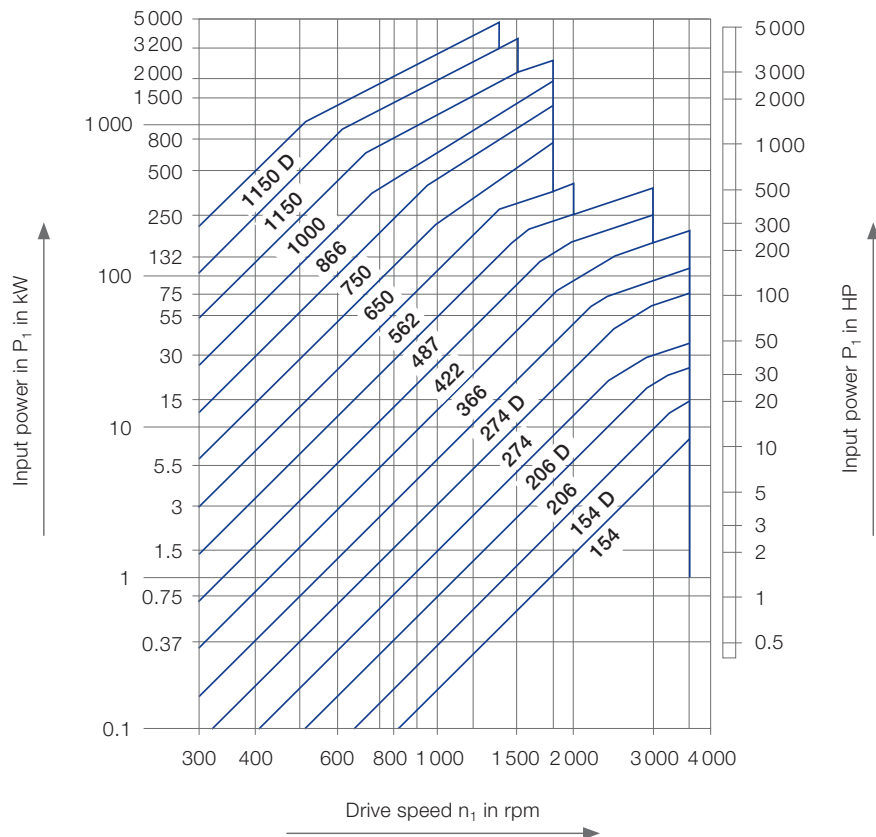
As a rule, constant-fill couplings from the Voith modular type range use the same main components. This is especially true for the pump impeller and turbine wheel. As a result, one single set of power characteristic curves applies to all variants – assuming the same operating fluid (same density) is used.

The power of the driven machine and the rated speed of the drive motor are essential design factors for the coupling. They primarily determine the coupling size. The profile diameter is specified as a parameter in the power characteristic curves. The size graduation corresponds to a power jump of 2 : 1 with justifiable minimum slip values.

Since  $P_P \sim D_P^5 |_{\omega_P = \text{const.}}$  (see 3.2.3), there is a progressive ratio of  $1 : \sqrt[5]{2}$ .

Fig. 32: Power characteristic curves for Voith fluid couplings with constant-fill

Operating fluid: mineral oil



The material strength of the main coupling parts determines the maximum permitted speed. After an initial estimated determination of the coupling size from the power data, the use conditions determine the design and variant.

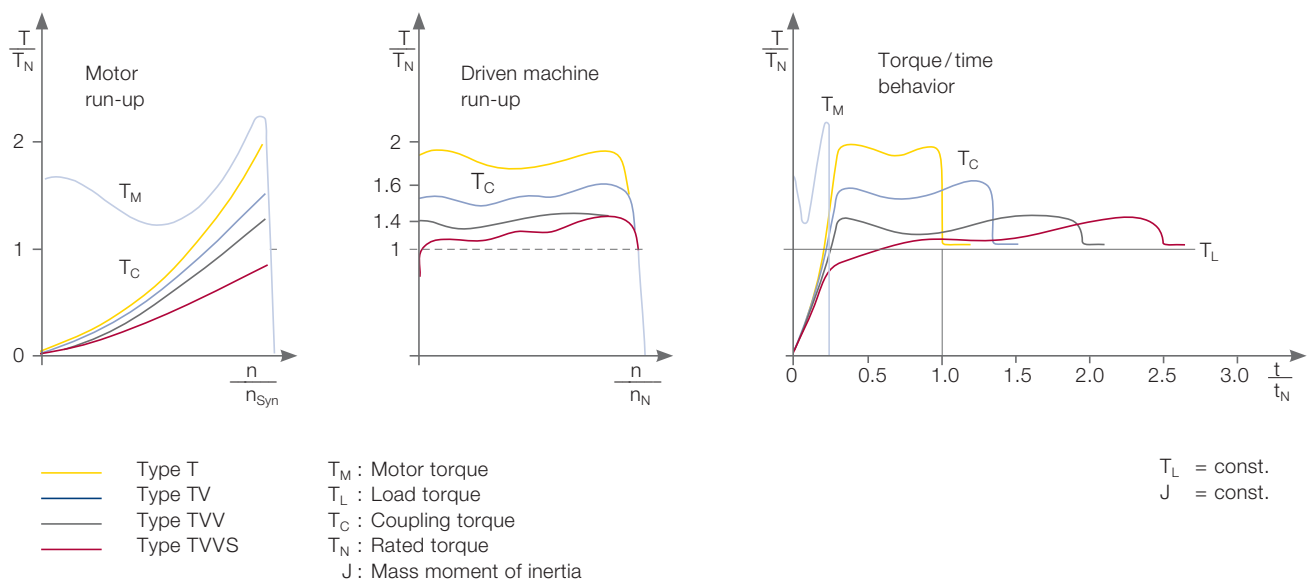
Finally, a check of the thermal load of the coupling is required. Generally, at least half of the start-up energy of each start-up process with slip must be converted into heat. The heat storage capacity and the amount of heat dissipation are therefore significant factors in the selection of the correct soft-start coupling.

### Characteristic curves

The various coupling designs differ significantly in their characteristic curves (see 4.1), which have a substantial effect on determining the start-up behavior. For the majority of applications couplings with time-dependent characteristic curves (see 5.1.2) are sufficient.

**Fig. 33: Comparison of start-up behavior of a driven machine with constant load torque and mass moment of inertia**

while using various coupling types. Drive motor is a squirrel cage asynchronous motor



## 5.2 Fill-Controlled Fluid Couplings

The integration of this type of coupling design into a drive system can vary significantly. In the simplest case, the scope of delivery only includes the pump impeller and turbine wheel as well as the surrounding shell; the operating fluid supply and its control is part of the overall system. With more complex requirements, self-supported coupling units with integrated operating fluid supply, cooling, monitoring and system control are used.

### 5.2.1 Basic design features

Fill-controlled fluid couplings are primarily supplied pre-assembled. The rotating parts, housing parts and the operating fluid supply are integrated into the drive system on-site. Fig. 34 and Fig. 35 show externally supported and self-supported couplings, executed as single and double circuit coupling with control principles "TP" and "TPK".

#### Control principle TP

A fill pump delivers the operating fluid from a reservoir into the coupling. At the same time, operating fluid exits the coupling via nozzles in the shell into the housing. The control of transmission behavior occurs by coordinating the inlet volume flow with the outlet volume flow. The (working) chamber, formed by the pump impeller and shell, rotates in line with the motor speed. The fill level in this rotating chamber generates a rotation pressure and thus an outlet volume flow, dependent on the diameter of the nozzles in the shell. An increase of the inlet volume flow creates a higher fill level in the working chamber, which results in a higher torque transmission capability. The opposite also applies. In any case, the maximum pump delivery must be greater than the outlet volume flow with completely filled coupling. Overflow bores in the inner area of the shell provide a fill limit. A start-up process is controlled or regulated via the adaptation of the inlet volume flow.

#### Control principle TPK

This principle rests on the metered filling of the rotating working chamber. Here also, operating fluid exits the working chamber via nozzles, but in this case into an annular shell connected to the pump impeller. A dynamic pressure pump (fixed scoop tube) siphons off the operating fluid from this annular shell and then conducts it through a heat exchanger via a catching ring back into the working chamber. An outer, enclosed operating fluid circuit results. Working chamber filling changes indirectly through the addition or removal of operating fluid from this outer circuit. The flow rate of the filling pump only depends on the desired fill time of the working chamber. Advantages of the TPK principle are a high level of control accuracy, small operating fluid pumps and a higher overall efficiency than that of the TP principle.

Fig. 34: Fill-controlled fluid coupling, type TP, externally supported, double circuit coupling

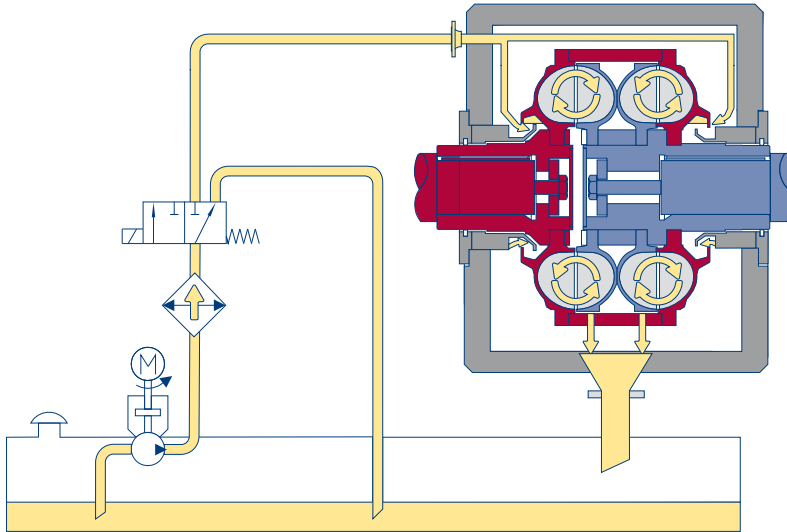
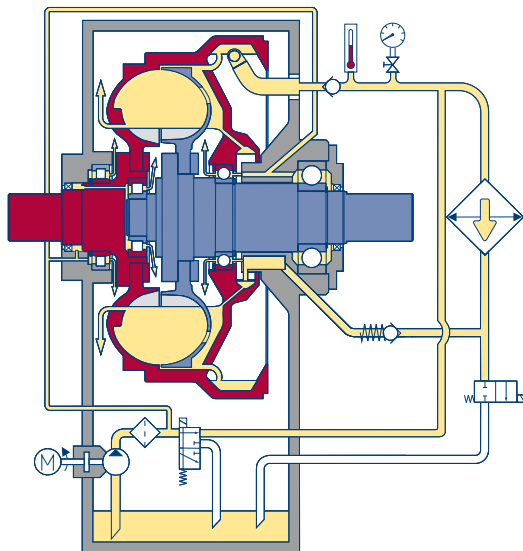


Fig. 35: Fill-controlled fluid coupling, type TPKL, self-supported, single circuit coupling



### 5.2.2 Application-oriented type range

The varying integration depth of the fill-controlled couplings in the drive systems requires a very flexible type range design and scope of delivery. However, there is a trend toward compact, self-supported designs with integrated operating fluid supply.

### 5.2.3 Selection criteria and hydrodynamic features

The main components of the fill-controlled fluid couplings are derived from the variable-speed coupling series. Essentially, this is the profile form of the vane wheels and the design of the function elements for the operating fluid circuit. The power characteristic curves for the fill-controlled couplings match that of the constant-fill couplings, as the graduation of the profile diameter and several design limits for both designs are the same. The power of the driven machine and the rated speed of the drive motor also mainly determine the coupling size in this case. The application and use conditions together form the main factors for establishing the control principle, the component scope, the execution of the operating fluid supply and the control and monitoring equipment.

#### Features of the application-oriented type range of fill-controlled fluid couplings

Design features	Standard variants	Comments
<b>Control principle</b>	TP	Single system, but lower control accuracy
	TPK	High control accuracy and good overall efficiency
<b>Number of flow circuits</b>	Single circuit coupling	Minimal installation length
	Double circuit coupling	Power transmission twice as high as that of a single circuit coupling with the same outer diameter; mostly balanced axial forces
<b>Operating medium</b>	Mineral oil	Good resistance to cavitation and corrosion
	Water	Non-flammable, environmentally friendly operating fluid
<b>Component scope</b>	Pump impeller, turbine wheel and shell	Flexible integration in a closed drive chain
	Pump impeller, turbine wheel, shell and housing	Integration in a modular drive system
	Coupling with housing bearing at driving and output ends	Independent unit
	Coupling with housing bearing on either drive or output end	Mounting unit
<b>Operating fluid supply</b>	External	Component in drive chain
	Separate with cooler	Modular design
	Integrated in housing with cooler	Completely independent unit
<b>Control/regulation</b>	External	–
	Only fill control and monitoring	–
	System control, regulation and monitoring	–

Fig. 36 describes two start-up processes for a belt conveyor – a typical application for fill-controlled couplings. The acceleration tension level and duration have a direct effect on its acquisition costs and service life. The gradual build-up of torque over time and the tight control of torque levels are therefore very important design criteria for conveying systems.

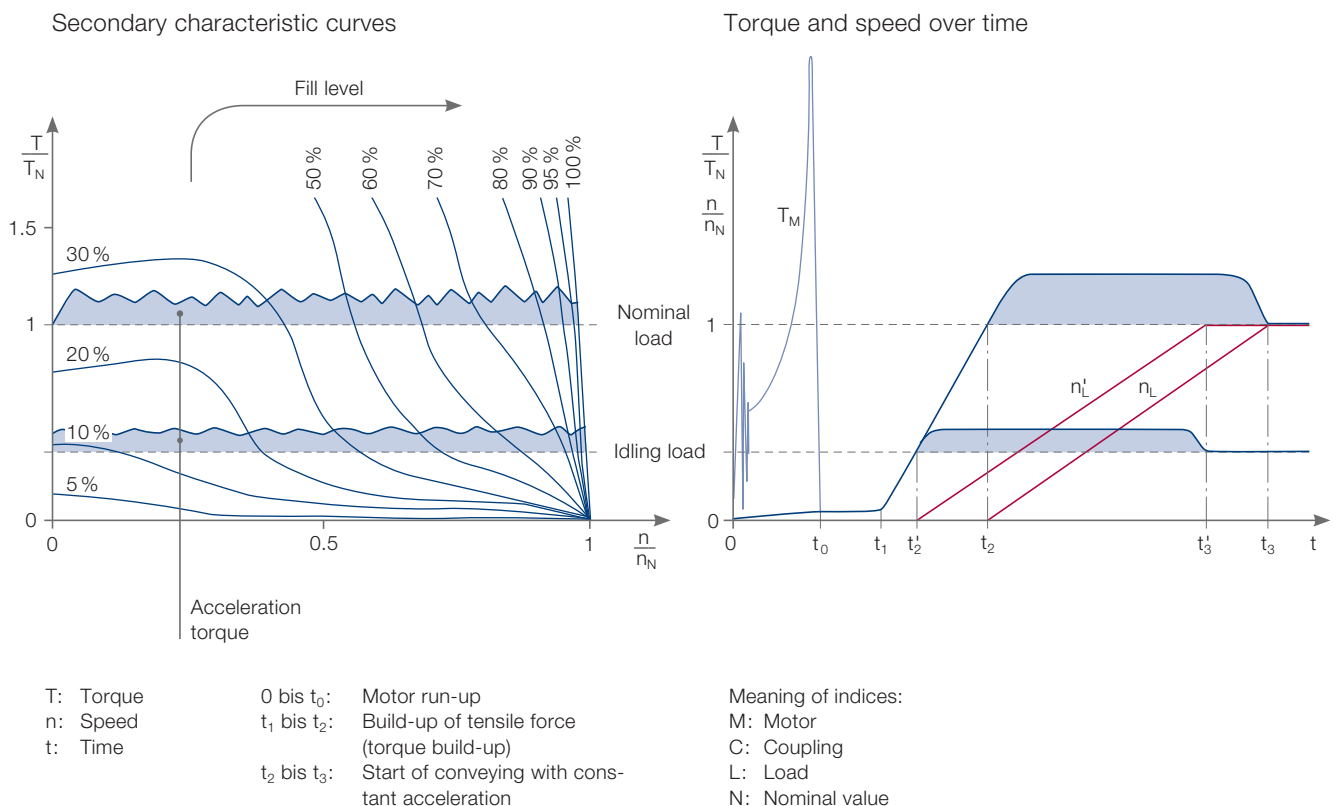
The pump impeller and turbine wheel are the same as those in the variable-speed coupling series. They produce a diversified set of secondary characteristic curves. With suitable control or regulation, the start-up of the belt conveyor is ensured within tightly pre-defined limits dependent on load.

The use of a fill-controlled fluid coupling in the drive of a belt conveyor, like the example described in section 4.2.1, brings additional noteworthy advantages for the entire system: The motor run-up and the start-up of the conveyor are independent of each other from a time perspective. Torque peaks

resulting from switching on the asynchronous motor – whose amplitudes can reach 4 to 5 times the rated torque – do not affect the entire system. Even high-voltage motors with low start-up torque (service factor below 10) run up safely thanks to the load decoupling characteristic of the fluid coupling. With multi-motor drives and weak power supplies, it is possible to have time-delayed activation of the individual motors to protect the power supply with no further action required. The couplings remain empty until all motors are activated. The torque build-up – and thus the tensile force in the belt – can occur gently and in a controlled manner in line with the quality of the belt. The torque limitation is possible within tight limits, dependent on the load.

Another typical use for fill-controlled couplings is within armored face conveyor drives in underground coal mining operations. The system properties of the hydrodynamic power transmission described above apply there in the same way.

**Fig. 36: Start-up process of a loaded or unloaded belt conveyor with fill-controlled fluid coupling (type TPK) in the drive**



## 5.3 Materials

The basic parameters from the hydrodynamic model relationships are torque, speed and the properties of the operating fluid. They also extensively influence the material selection for the main components of the coupling. The table below shows the most important criteria selecting the material.

### Criteria for selecting the material used for main coupling components

<b>Function</b>	Profile geometry, vane format, flow channels, density, mass
<b>Stress factors</b>	Centrifugal forces, fluid pressure, torque, forces from change in temperature
<b>Manufacture</b>	Costs for raw parts, processing, devices and models
<b>Process suitability</b>	Maintenance costs, corrosion resistance, abrasion resistance (for a contaminated operating medium), spark formation (in potentially explosive areas)

It is preferable to use cast aluminum alloy parts for the main components of constant-fill couplings with medium stress levels and for smaller series. Alloys of this kind have a favorable strength to density ratio and also offer low weight and good processing capability. For medium series, the most economic production method is more likely to determine the material selection. For large series, an automated steel plate lightweight construction is usually the most cost-effective.

Cast steel or quenched and tempered steel with electrochemically or mechanically processed flow channels is a good material selection if there is high stress at high speeds.

In marine propulsion, it is generally the application that determines the selected material. Typically these are smaller batch sizes, usually with larger dimensions and corresponding stresses. For example, aluminum alloys are antimagnetic; spheroidal cast iron allows a higher degree of elongation when stressed by shock; steel plates enable cost-effective vane welding; and copper-bronze has good resistance to corrosion.

## 5.4 Operating Fluids

In hydrodynamic couplings, a circumferential fluid flow transfers the power from the pump to the turbine. The operating fluid is therefore of great significance; it is an important design element for the whole system. The density and viscosity of the fluid are of primary importance. Another key task is to take in the heat resulting from the power loss and then transfer it to the coupling components.

The properties that the operating fluid must fulfill in practical use are numerous and depend on the design of the coupling and its integration into the system as a whole. The operating fluid is selected on the basis of the parameter requirements for the power transmission, the material compatibility, the application range and the process capability. The minimum lubricant capability for antifriction bearings and the compatibility with sealing materials are dependent on the design.

### 5.4.1 Standard operating fluids

HLP (mineral-oil based) hydraulic oils within the ISO VG 32 viscosity class are the standard operating fluids used for fluid couplings. The details in design documentation, especially characteristic curve representations, usually refer to these operating fluids.

The viscosity is significant to the power transmission because it has a considerable effect in determining the friction in the flow channel. The lower the viscosity, the lower the speed losses of the circumferential mass flow in the flow channel. The influence of the viscosity on the characteristic curve course is usually negligible when using standard operating fluids in the authorized temperature range.

In special cases, e.g. use in low temperatures, it is possible to adapt the viscosity class. A check of the influence on operating behavior (characteristic curve) is required in such circumstances.



## Requirements chart for operating fluids in fluid couplings

Requirements	Fluid properties	Fluid types					
		Minimum requirements for constant-fill couplings	Expanded requirements for fill-controlled couplings	Standard	H <sub>2</sub> O, HFA	HFD-U <sup>1</sup>	HEES <sup>1</sup>
<b>Energy transmission</b>	High density	●		✓	▲	▲	▲
	Low viscosity	●		✓	▲	✓	✓
	High viscosity index	●		✓	▲	▲	▲
	High specific heat	●		✓	▲	✓	✓
	High service temperature	●		✓	▽	▲	▲
<b>Cost-effective manufacture</b> (Materials and components)	Sufficient corrosion protection	●		✓	K	✓	✓
	No nonferrous metal reaction	●		✓	K	✓	✓
	Minimal cavitation trend	●		✓	▽	✓	✓
	Resistant to oxidation/ageing	●		✓	▲	✓	✓
	Compatible with sealing material	●		✓	✓	✓	✓
	Capable of minimum lubrication	●		✓	K	✓	✓
	Good air intake/-delivery		●	✓	▲	▶◀	▶◀
	Minimal foam formation		●	✓	▲	▶◀	▶◀
	Pressure stable		●	✓	▲	✓	✓
	Sufficient wear protection		●	✓	▽	✓	✓
	Non-hydrolytic		●	✓	▲	▽	▽
<b>Broad application</b> (Safety, environment and external effects)	Non-toxic	●		✓	▲	▲	▲
	Suitable for low temperatures	○		▶◀	-	▶◀	▶◀
	Non-combustible	○		-	▲	S	-
	Environmentally friendly	○		-	▲	W	▲
<b>Process capability</b>	Available worldwide	●		✓	▲	▽	▽
	Preservative compatible	●		✓	K	✓	✓
	Secured disposal	●		✓	▲	▽	▽
	Cost-effective	●		✓	▲	▽	▽

● Required  
○ Special application

✓ Meets Standard  
▲ Above Standard  
▽ Below Standard

- Not met  
▶◀ Variation is possible

K: Requires constructive measures  
S: Flame-resistant  
W: Note water endangerment class

<sup>1</sup> Requirements for HFD-U and HDS only apply to tested types

### 5.4.2 Special operating fluids

Mineral oil was often not an option as an operating fluid for primary applications in the underground mining industry or for use in water protection areas. This required the approval of non-flammable or flame-resistant and environmentally friendly operating fluids – for both constant-fill couplings and for fill-controlled couplings.

Water or HFA fluids (oil in water emulsions) fulfill the requirements of the underground use. Various disadvantages limit the use predominantly to this application area. The low service temperature and the cavitation tendency limit the power spectrum of the coupling.

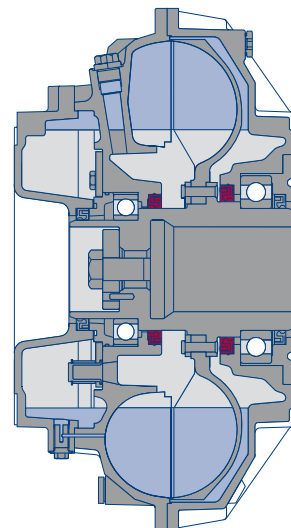
Fig. 37 shows design measures that permit the use of water or HFA fluid in a fluid coupling. Specifically, these are:

- Shaft seal rings to shield the bearing chambers
- Lubricating the bearings with low-viscosity grease (life-long grease filling)
- Rust-proof steels
- Hard anodized, oxidized aluminum cast parts
- Low-temperature fusible plugs

The further development of flame-resistant HFD-U fluids (water-free, synthetic fluids) depicts a friendlier image. They do not require additional design measures for the fluid coupling. Parallel to this development is the introduction of biodegradable operating fluids based on synthetic ester (HEES fluid). Both operating fluids have successfully performed in bench tests and are already in use.

**Fig. 37: Constant-filled fluid coupling**

for an operating fluid of water or HFA



### 5.4.3 Special design aspects of constant fill couplings

One design feature must be considered in conjunction with operating fluids for fluid couplings with constant fill: The couplings are sealed to the outside, and the exchange of gases or fluids with the environment is not easily possible. Measures to limit the thermal inner pressure must therefore be implemented: The design arrangement of the fill opening is designed so that the maximum fill level is 80 %.

The design of the coupling surface ensures the conductance of the slip heat that builds up during the start-up process and in nominal operation. A limitation of the start-up frequency to reduce thermal stress may be necessary.

In addition, installed thermal limit switches enable targeted reactions to excessive temperature – before the thermal stress boundary is reached. Installing an additional thermal measuring unit is especially advantageous, since it enables not only temperature monitoring but also optimal process control (for example at the load limit). All constant-fill couplings also have fusible plugs that release an opening if the thermal stress limit is exceeded. The operating fluid exits from this opening and the traction is interrupted.

Non-contact temperature measuring equipment for fluid couplings



Voith Turbo GmbH & Co. KG  
Voithstraße 1  
74564 Crailsheim, Germany  
Tel. +49 7951 32-409  
Fax +49 7951 32-480  
startup.components@voith.com  
[www.voith.com/fluid-coupling](http://www.voith.com/fluid-coupling)

**VOITH**  
Engineered Reliability