

nextlevel

by Voith Paper — N° 11

→ 12

Celebrating 10 Years
of BlueLine

Securing best-in-class
stock preparation for
maximum efficiency and
sustainability

→ 24

Mission: Disruption

Meet the trailblazers
in carbon-neutral
papermaking

→ 34

Future(s) Unfolding

A step-by-step guide
to unlock the
full potential of the
autonomous paper mill



Future- proofing n w!

Respecting the planet,
driving growth and profitability

Editorial nextlevel N° 11



Dear Readers,

How can we continue to push the boundaries of papermaking in a way that respects the planet and secures profitability? This issue explores how best practices, groundbreaking innovations and close collaborations are futureproofing our industry now.

Meet the people behind our trailblazing CO₂-neutral pilot plant project with Essity, which has the potential to seriously disrupt the entire papermaking process and radically reduce water and energy consumption. Discover why our customers agree that 10 years of our BlueLine OCC stock preparation technology is a cause for celebration, and how other bold decisions have also led to resource-efficient innovations. These include the use of bio-based materials in roll covers, energy-busting upgrades to the popular MasterJet and NipcoFlex shoe press technologies as well as the revolutionary 3D-formed cellulose-based packaging from Yangi.

Futureproofing papermaking requires more than innovative technology. We need bright and curious minds to drive us forward. On the cover, we feature two young talents at Voith Paper. In this issue, you can read my answers to their challenging questions about the future of our industry. Enjoy the read!

Andreas Endters

Andreas Endters
President & CEO Voith Paper



12

10 years of profound BlueLine innovations set the industry benchmark

Contents

04 **News**
A Quick Round-Up
from the world of Voith Paper

06 **Securing the Future of Papermaking**
Voith Paper CEO Andreas Endters on the key sustainability and profitability drivers in the paper industry

12 **Celebrating 10 Years of BlueLine**
How BlueLine became the gold standard in OCC stock preparation technology

18 **A Mindset for Innovations**
The customers saving energy and boosting performance with the innovative MasterJet 4Tec and HighPerformance Press solutions

Full-line supplier





06

Deep in conversation:
Voith Paper CEO Andreas Endters
with two aspiring apprentices

18

Taking a big step forward in paper machine
technology: the MasterJet 4Tec

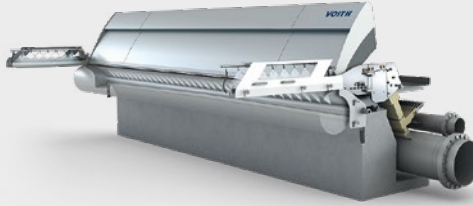

24

R&D commitment:
reduce water consumption by 95 percent

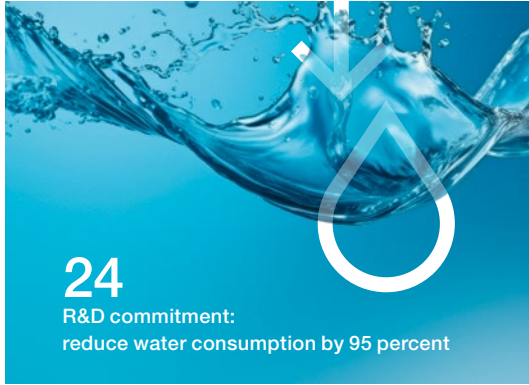

Sustainability

- 24 **Mission: Disruption**
A brand-new CO₂-neutral pilot line and a trailblazing collaboration with Essity are set to decarbonize and radically reduce water consumption along the entire papermaking process
- 28 **A Recipe for Success**
The end-to-end solution for the sustainable production of bio-degradable wet-laid nonwovens from 100% renewable raw materials
- 30 **In the Loop**
Shrinking the carbon footprint of wear parts for the press section through closed-loop recycling, bio-based materials and low-carbon production sites
- 34 **A must-have for the future:**
intuitive autonomous tools and processes

Efficiency

- 34 **Future(s) Unfolding**
Best practices for continuous improvement and profitability on the journey to the autonomous paper mill
- 38 **Full Speed Ahead**
Asia Symbol and Voith achieve highest design speed breakthrough in record time for Rugao BM 13
- 39 **The Trendsetter**
A sophisticated rebuild for Shandong Huatai Paper is setting new standards in high-quality graphic paper for Asia
- 40 **The Full Cycle**
A detailed 12-month planning cycle ensures Klabin's annual maintenance shutdown is safe, smooth and on schedule every year
- 41 **Fine-Tuning the Mill**
How CONTROLSuite empowers Domtar to better understand, monitor and tune control systems at the Rothschild Paper Mill in the U.S.
- 42 **Q&A**
The Swedish start-up Yangi leading a revolution in sustainable packaging

Publishing Information
Issue N° 11, October 2024

Publisher:
J.M. Voith SE & Co. KG
St. Poeltener Str. 43
89522 Heidenheim, Germany
nextlevel@voith.com

Responsible for Content:
Anna Dennerlein,
J.M. Voith SE & Co. KG

Editor-in-chief:
Tamara Lemm,
J.M. Voith SE & Co. KG

Author/Editor:
Deborah Capras

Design:
stapelberg&fritz gmbh,
Stuttgart, Germany

Printing:
C. Maurer GmbH & Co. KG,
Geislingen/Steige, Germany

Copyright:
No part of this publication may be reproduced, distributed or transmitted in any form or by any means without the prior written permission of the publisher, and none of the content contained herein may be used in whole or in part in other works in any form.

On the cover:
Andreas Endters, President & CEO Voith Paper, in conversation with Lisa Heisele and Edvin Fetahovic, two apprentices who share a passion for papermaking.

Photo credits:
Cover page, pp. 05–11: Rafael Krötz (photo); pp. 05, 13, 15 (left)–16, 18–22: Ray Sono AG (rendering); pp. 12–17, 23, 30–32, 39–41: s&f (illustration); p. 15 (right): defortec GmbH (rendering); p. 22: Jan Hosan (photo); pp. 23 (left), 25–27, 33 (left)–37: shutterstock; p. 24: youworkforthem; pp. 25–27: Elias Blumenzweg (photo); pp. 28–29: Mattia Sullini (rendering); p. 29: Toscotec (photo); pp. 33 (right), 39: Joe Qiao (photo); p. 36: gettyimages (photo); p. 38: Xiaodong Gong (photo); pp. 42–43: Yangi; All other photos are from Voith.

[LinkedIn](#) [YouTube](#) [WhatsApp](#) [voith.com](#)

Your feedback:
If you have any questions or comments about this issue of nextlevel, please contact us by email at nextlevel@voith.com or via: www.linkedin.com/company/voith-paper www.youtube.com/voithgroup

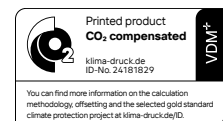

Game changer SensorBlade for tissue machines

Voith's proven intelligent SensorBlade service for profiling of the doctoring system is now available for tissue machines. Sensor-based measurement technology is a cutting-edge innovation in the field of creping and doctoring. It uses advanced sensors and analytical tools to provide mechanical health monitoring and diagnosis. SensorBlade improves reliability by enabling visibility of the profile data and by detecting abnormalities more effectively and efficiently across the contact area of the creping blade. With this true line load profile visualization, it is possible to identify invisible sources of misalignment and ensure proper alignment between Yankee and creping blade within a short timeframe. "Customers who have trialed the new service uncovered inadequacies in the doctor profile that had gone undetected using conventional testing methods," notes Ralf Moser, Global Product Manager Finishing Section & Doctoring Solutions at Voith Paper. "As the Yankee dryer cylinder and creping function are the heartbeat of tissue production, this is a game changer for tissue manufacturers."



The EdgeDeckle-S: new shape, innovative design

Three new features set the EdgeDeckle-S apart. This new generation of Voith's proven EdgeDeckle solution, which is used to control the edge on Fourdrinier wires, ensures a perfectly clean wire edge for a smoother run. The first standout feature is the unique S-shape side shield module, which efficiently eliminates edge waves. The second is the upgrade to the sealing design. A new type of Teflon sealing strip completely closes the gap between deckle board and wire. Both the side shield and sealing strip can be easily adjusted without tools, even while the machine is running. The third is key to the overall user-friendliness of the design. Unlike conventional edge controls that are complicated to move, the EdgeDeckle-S requires minimum effort to adjust or remove. For wire changes it's simply swiveled into service position, which frees up instant access. After the wire change or maintenance, the EdgeDeckle-S is lowered back into the operating position and no further adjustments are necessary. The intuitive and effective design, which is available in three sizes, is proving popular with papermakers. "At first sight, the new EdgeDeckle-S may look familiar," explains Michael Drescher, Operational Global Product Manager at Voith Paper. "The difference is the S-module requires no sensitive or time-consuming adjustments. Combining easy handling and reliable features, the new EdgeDeckle-S is an essential tool for papermakers to improve runability and paper quality."

EdgeDeckle-S Key new features



Side shield

Unique, adjustable S-shape eliminates edge waves



Sealing

Teflon sealant stays in direct contact with the wire and is easily adjusted



Service position

The innovative design makes wire changes and maintenance easier and fast



For more insights, watch the video!

C-bar Vertecs boosts screening throughput by over 20%

Voith's innovative C-bar Vertecs profile bar design enhances screening throughput by over 20 percent, while also increasing operational reliability. This increased performance is achieved without sacrificing screening efficiency. Sticky separation remains the same or even better compared to the original C-bar basket. The new profile bar design builds on the proven strengths of the original C-bar technology, which has been the leading screening technology for over 35 years. C-bar Vertecs is suitable for all BlueLine and older Voith machines, as well as third-party equipment. Since early 2024, the first industrial-sized prototype has been running in fine screening successfully at an OCC (old corrugated containers) paper mill.

05

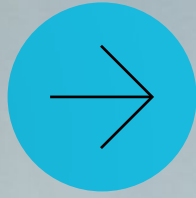

Page

22

#full line supplier

Discover the potential of
holistic papermaking solutions.

Securing
the

future of
papermaking



In conversation with the next generation of papermakers, Andreas Endters, Voith Paper President & CEO, outlines how to master the challenges for a sustainable future. One that is boosted by smarter innovations, sustainable solutions and digital profit drivers. As well as curious minds.



In conversation

Andreas Endters (left), President & CEO, Voith Paper, with Lisa Heisele and Edvin Fetahovic, two apprentices who share a passion for papermaking.

Lisa Heisele: What makes papermaking an attractive career choice – in particular for Millennials, Gen Z or even Gen Alpha?

Andreas Endters: Paper is a great sustainable material with a future. It's based on renewable fibers, it's recyclable – and biodegradable even if it is not disposed of in the correct way. Younger generations have an exciting opportunity to take ownership, build on these characteristics and make the papermaking process even more sustainable.

Lisa Heisele: Particularly for our generation, it can often feel like there's not enough being done to mitigate climate change. Are you satisfied with the pace of change in paper-making?

Andreas Endters: To some extent, yes. When it comes to the decarbonization of industrial processes, for instance, the paper industry is leading the way. Today in Europe, 61 percent of the fuel used in the pulp and paper industry comes from biomass. Paper is also a role model for the circular economy. We see this in Europe and in North America, where the recycling rate for paper and board is high, at around 80 percent, while virgin fiber comes from sustainably managed and certified forests. In recent decades, water consumption in paper mills has been drastically reduced. Thanks to our AquaLine water treatment systems, our customers can already run a closed-loop operation where no effluent water is produced. Taken together, this means that a lot has been achieved.

But am I satisfied? Not by any means. We see even greater potential to make the papermaking process more resource efficient and less energy intensive. And we are doing more to support the circular economy, through the refurbishment and re-use of wear parts, the recycling of press fabrics and the first-ever bio-based polyurethane and composite roll covers. These are great innovative examples of how we can reduce waste and significantly lower the carbon footprint of our products.

Edvin Fetahovic: Innovation is clearly important to you. I'd be interested to know if you have a favorite innovation – from the past or in the pipeline?

Andreas Endters: Our OnEfficiency.Strength application is both my favorite innovation and my favorite digital tool. Using artificial intelligence, we have developed a virtual sensor that provides our customers with the strength characteristics of the produced paper in real time. This allows the operators to minimize basis weight and/or starch application. In a multitude of references in the field, this innovation has already increased resource efficiency and saved substantial sums of money for our customers.

Edvin Fetahovic: A lot of innovative technology is causing massive disruption in many industries and job markets. Where do you see the most disruptive influences in papermaking that will ultimately also benefit customers?

Andreas Endters: With our Papermaking for Life sustainability program, we have set clear targets to make the papermaking process more sustainable by 2030. Essentially, this means that every euro we invest in R&D goes into innovations that target energy use, water consumption and fiber losses – the things that matter to our customers. To be fast, agile and market centric, we work on R&D projects in partnership with our customers. In one truly exciting project, we are currently developing a disruptive papermaking process with Essity, a leading global hygiene and health company, that uses 95 percent less water and up to 40 percent less energy. This is going to be a quantum leap for the industry.

Lisa Heisele: That sounds impressive, but can you do more now?

Andreas Endters: Absolutely! Using electric boilers for steam production powered by renewable energy, a low-carbon papermaking process is already a reality today. For instance, in Portugal, Toscotec is currently installing the first fully electrified tissue paper machine that runs solely on green energy. With our energy-optimized products and processes, including digital tools, we are driving the specific energy consumption down even further.

Our R&D innovation hubs are also helping to get rid of plastic waste by replacing plastic material with paper-based alternatives. Five years ago, we invested heavily in our pilot coater in Heidenheim, Germany, to develop innovative



“To be fast, agile and market centric,
we work on R&D projects in
partnership with our customers.”

Andreas Endters
President & CEO, Voith Paper



Andreas Endters
President & CEO of Voith Paper since 2017.
With a career spanning over 30 years
in the paper and pulp industry, Andreas Endters
has in-depth knowledge of the papermaking
processes and market opportunities.



“Who wouldn’t want to be part of the team

that can make our world better with paper?”

Andreas Endtlers
President & CEO, Voith Paper



Lisa Heisele is a business apprentice on a three-year dual study program at Voith, which has provided many interesting insights into the paper industry. “I never would have thought that papermaking would be so complex and interesting,” Heisele says. “I am all the happier to have been able to gain this experience.”



Edvin Fetahovic is currently studying mechanics on a three-year apprenticeship program at Voith. Attracted to Voith by the many diverse career opportunities, Fetahovic has decided to become a specialist in winder technology. “The winder plays an incredibly important role in papermaking,” says Fetahovic. “I’m impressed by the innovative technology and combination of precision and efficiency every day anew.”

barriers together with our customers. Our development partnership with Koehler Paper is a role model in this respect. With the help of bio-based and biodegradable functional barriers we can protect food and other goods against humidity, steam, grease and smell. Particularly in food and pharmaceutical packaging, we see even more possibilities to switch from plastic to bio-based materials. Since consumers and retailers understand that paper is the more sustainable material, we see a huge potential for further customer partnerships in this area.

Edvin Fetahovic: I'd like to ask more about your view on digital tools. The hype and reality around artificial intelligence and machine learning is upending many industries and the job market. What impact is it having in papermaking?

Andreas Endters: Digitalization has the power to make the papermaking process more autonomous and more resource efficient. Our Papermaking 4.0 automation and digitalization portfolio is a pioneer in this respect, as it increases plant availability and efficiency. Besides driving sustainability, improving resource efficiency also helps our customers remain competitive with their total cost of ownership.

Lisa Heisele: I've heard a lot of different views on the future of papermaking. What does the autonomous paper mill mean to you?

Andreas Endters: Viewed from a demographic perspective, the autonomous paper mill is a must for the future, but it is also a great opportunity to drive competitiveness – and create exciting job opportunities.

AI is helping us here to use the vast amount of data generated in paper mills to develop smart algorithms that help us to autonomize process islands. By connecting these islands step by step, we will make the vision of an autonomous mill reality. At the same time, we need easy-to-handle user interfaces, which is something that our MillOne system will deliver. In fact, this is another area where we are making rapid progress in partnerships with our customers.

Becoming more autonomous does not mean that there will be no employees. The plant will still need highly skilled operators to keep the systems going and provide support in the event of problems. In the autonomous mill, people will have more time to work on optimizing processes and tools even further. There is always room for improvement.

Edvin Fetahovic: What about improvement on a personal level? Given the rapid rate of technological innovation, which skills are papermakers most likely to need that are also the most durable?

Andreas Endters: From my own experience, I would say it is important to have an open mindset and to be prepared for life-long learning. The evolution of the papermaking process will not stop. A passion for technology and automation is of course needed since the plants and process controls will remain highly technical.

I believe there is a bright future for curious minds like yours.

Lisa Heisele: Finally, a word of advice for anyone working in the paper and pulp industry?

Andreas Endters: First, instead of feeling frustrated with the pace of change, I urge all generations to be proactive and look for opportunities where they can be part of a collective effort to make a positive impact. At the same time, it's important to understand that success cannot be taken for granted, neither as a person, nor as a company. To move forward, we have to cope with challenges and adapt quickly to change. I like to think in terms of volatility, uncertainty, complexity and ambiguity, or VUCA. This acronym captures the dynamic world in which we now live and the multitude of challenges we face.

Working in an industry that produces paper and board – bio-based, recyclable and biodegradable materials – should be a great motivator for anyone who is interested in sustainability. The broad range of applications – from information carrier, packaging materials, health care and hygiene products to arts, crafts and design – means that everyone can identify with paper. And who wouldn't want to be part of the team that can make our world better with paper?

For more details on how Voith is future-proofing papermaking, check out these articles in this issue.



Autonomous paper mill

Expert guide to the customer journey
→ page 34



Sustainable wear parts

Bio-based innovations and smart recycling
→ page 30



The BlueLine advantage

Ten years of customer-centric solutions
→ page 12



Disruptive innovation

A quantum leap for tissue production
→ page 24

Future-proofing !

A brave and radical rethink brought the BlueLine portfolio to life. Now, 10 years later, it's the industry's gold standard for robust, resource-efficient stock preparation lines for sustainable papermaking. What's next on the horizon?

Celebrating 10 years

of BlueLine

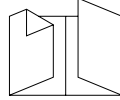

Look inside to explore the BlueLine milestones!

A jump-start to a new era

"The BlueLine portfolio didn't come out of the blue," explains Steffen Bassmann, Director Product Group Fiber Systems at Voith Paper. "Essentially, 2014 marked the culmination of a series of profound innovations – and the jump-start to a new era in stock preparation." At the time, Andreas Heilig was responsible for Products Fiber Systems at Voith Paper. Now, with more than 30 years of experience at the company, he remembers the lead-up to BlueLine as a challenging period for the pulp and paper industry. "With digital media came a decline in demand for high-end plants for graphic paper products. Meanwhile, the demand for packaging paper grades was rising, driving demand for OCC stock preparation systems," Heilig notes. Voith responded to these trends by re-engineering the main performance drivers in the stock preparation portfolio and designing breakthrough concepts on top. "By massively strengthening, standardizing and streamlining our product portfolio and tailored services, we have secured the highest runability, efficiency, quality and safety standards for our customers," Heilig adds. "Today, we have earned a reputation for delivering customized systems that are the benchmark for modern plants. They are easy to install, operate and service anywhere in the world."

Customer benefits in the spotlight

Each innovation – both for new machines and for performance parts – was developed with a strong attention to customer requirements for higher runability, reduced energy and water consumption, and lower investment costs for stock preparation lines. Papermakers enjoy the results of Voith's best-in-class innovations and standout services for new lines, comprehensive rebuilds and upgrades that target specific issues, such as reducing the energy costs of an existing line on a smaller budget. "We provide robust machinery, highly automated processes and expert services that save fiber, water and energy," says Bassman. "And we continue to do this on a scale that nobody thought possible before 2014."

➔ **20** product families

In recent years, over 20 innovative comprehensive product families have been launched

➔ **85** Major BlueLine OCC (old corrugated container) production lines in operation around the world

➔ **50 %** BlueLine share of the international market for large OCC production lines

➔ **35,000,000** tons

Estimated annual production capacity of all BlueLine OCC systems sold to date

**"BlueLine is future-oriented
German engineering
and tailored services at their
very best."**

Steffen Bassmann
Director Product Group Fiber Systems,
Voith Paper

Future-proofing !

The full scope: As a full-line supplier, Voith covers every aspect of stock preparation and seamlessly delivers the industry-best integrated solutions for WSR (water, sludge, reject) and wastewater treatment. By combining the strengths of the BlueLine portfolio with state-of-the-art BTG and Meri solutions, customers maximize performance, efficiency and sustainability. For instance, the Aqualine water management system measurably reduces fresh water consumption.

Sustainability: As part of Voith's Papermaking for Life sustainability program, the targets for stock preparation are even more ambitious than they were back in 2014. Intensified recycling efforts lead to new sources of recycled fibers. With an optimized recycling process, Voith is committed to achieving a recycling rate of 90 percent in Europe by 2030. The overall goal is to minimize the carbon footprint in papermaking.

Autonomous stock preparation: As the robust BlueLine machinery is less sensitive to process fluctuations, it is ideally suited for autonomous processes. Papermaking 4.0 digital and automation solutions for stock preparation help customers achieve more stable processes and deal with the fluctuating quality in raw materials and the rising cost of energy and resources. Furthermore, increasing the level of autonomous processes in stock preparation can help offset the skills shortage in the industry.

2014

IntensaPulper

IntensaMaXX
InfiltraDiscfilter

The lighthouse project
The world-leading InfiltraDiscfilter is the innovation that best symbolizes the BlueLine philosophy. Voith development teams drew on their imagination and experience in the field to develop a more compact and robust design for disc filters that would also perform better than conventional systems. "The key learnings from this lighthouse project would ultimately feed into subsequent product developments," explains Bassmann. "We proved it was possible to identify and unlock untapped potential for improving performance that customers would value." Today, the InfiltraDiscfilter stands for outstanding filtrate quality with less than 150 mg/l suspended solids and substantial savings in fresh water consumption.

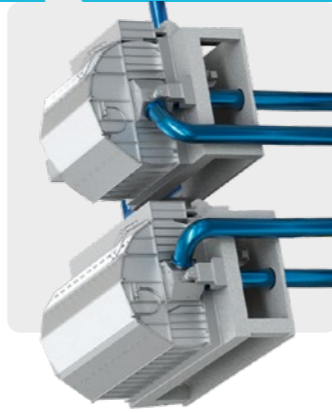

The reliable and energy-efficient lighthouse innovation for super clear filtrate.

InfiltraDiscfilter

IntegraGuard
IntegraScreen
IntensaDrum

Repeat pioneer:
Modern Karton, Turkey

In 2014, Voith provided the complete production line PM 5 for Modern Karton, the largest manufacturer of cardboard packaging and packaging paper in Turkey. It includes a modern stock preparation line equipped with BlueLine innovations such as the IntensaPulpers, several IntensaMaXX machines for detaching, InfiltraDiscfilter and IntegraScreen/IntegraGuard screening machines. The high-speed facility handles raw materials with high reject rates of up to 15 percent. As one of the first to install three smart InfiltraFiner DG refiners, Modern Karton continues to play a pioneering role in papermaking. It has recently ordered a new BlueLine OCC line to process 2,400 bdt/d recovered paper, giving it one of the highest pulping capacities in the market.

"We are proud to be among the pioneers in using BlueLine innovations, which gives us significant benefits in increased fiber yield and remarkably reduced energy consumption. These outstanding results are supporting us in taking our operations up to the next level of performance and process stability."

Ersin Sahin
Production Director,
Modern Karton

2016

High reliability, high yield
The Intensa ScreenDrum, which includes features for efficient reject washing with minimum fiber loss, was the perfect addition to Voith's market leading LC-Pulping (low-consistency) concept. This system combines proven components, including the IntensaPulper and IntensaMaXX, to ensure outstanding contaminant removal with minimal fiber loss. As all subsequent process stages depend on the good performance of the pulping process, it is essential for the overall performance of the stock preparation line.

2018

InfiltraScrewpress
InduraHiClean
InduraPro
HiCon Discfilter
Intensa ScreenDrum

Powerful combinations with performance parts
When combined with maintenance-free FloWing discs, the latest generation of Voith's InfiltraDiscfilter can withstand greater process fluctuations. As a result, they deliver consistent filtrate quality and increase production capacity by 20 percent compared to conventional disc filters.

"It's not only steel, it's also the people that make a plant operation successful. Given the coordination necessary for a successful start-up, it's incredibly rewarding for the project team to see how BlueLine reliably supplies high-quality stock so the mills can run at full capacity. Our customers are always impressed that their paper machines are never left waiting for stock."

Tomislav Brazzinec
Leader, Commissioning Stock Preparation,
Voith Paper

"Thanks to the BlueLine stock preparation system and the XcellLine paper machine, we have achieved high energy efficiency and can produce packaging papers in a resource-saving way. Our trust in Voith has paid off, we are extremely satisfied with the solutions."

Armin Vetter
Managing Director Production and Technology,
Schoellershammer

Super resource-efficient production:
Schoellershammer, Germany

In December 2016, the BlueLine stock preparation system and XcellLine PM 6 paper machine were successfully commissioned at the Schoellershammer paper mill in Dürren, Germany, and have been continuously optimized ever since. All BlueLine solutions, including the InfiltraDiscfilter with FloWing filter discs, TwinPulp LC pulping system and Intensa technology, contribute significantly to the exceptionally low energy and water consumption at the mill. Together PM 5 and PM 6 have an annual production capacity of 535,000 tons of packaging paper. For each ton of finished paper, electricity consumption in the recovered paper stock preparation totals around 60 kWh/t. In contrast, an average OCC line would require a specific electricity requirement of more than 120 kWh/t.

2020

Partner for the whole life cycle
The average quality of today's recycled materials is known to cause significant wear, resulting in costly and time-consuming maintenance efforts to secure stable production. Voith engineers provide expert services and refurbishment solutions for process equipment, with resounding success for customers. The innovative design of the CurvedBar screen plate, for instance, reduces the shear forces on the screen plate. This reduces the risk of breakage, extending its lifetime and ensuring that far fewer contaminants are shredded. As a result, the operating costs are much lower, the quality of the stock suspension is improved, while the amount of small reject is reduced.

2021

InduraClean

The modular cleaning technology can reduce specific energy use by up to 50 percent.



2023

Smart, efficient, unique

The InfibraFiner DG sets new industry standards, this time in smart, resource-efficient and user-friendly refining. The no-load power control, for instance, ensures up to 25 percent idle power can be saved during the service life of the filling. Operating the refiner is made easier with the SmartLight, a sophisticated monitoring and communication system that indicates the real-time status of the refiner, and the simplified rotor changing device.

Record-breaking capacity:

Sichuan Huaqiao Fenghuang Paper, China

With a design capacity of 2,200 tons a day, the BlueLine OCC stock preparation system for Sichuan Huaqiao Fenghuang Paper is the largest OCC line in the Asian market. At the Guanghan site, the BlueLine solution provides stock for the XcelLine paper machine, PM 6, which produces high-quality packaging paper in the range of 90 to 170 gsm and has an annual production capacity of about 400,000 tons. The BlueLine set-up achieves an excellent overall stickies reduction, which ensures a stable and reliable operation.

BlueLine OCC Process

InfibraDisp

CurvedBar

IntensaDrum Duo

InduraClean

InfibraFiner

BluePulp LC

IntensaPump



80th BlueLine installation: Papierfabrik Palm, Germany

With an annual production capacity of 750,000 metric tons of containerboard, Papierfabrik Palm in Aalen depends on the customized BlueLine stock preparation system, consisting of the complete BlueLine portfolio, to deliver up to 2,700 metric tons of stock every day. Five hundred metric tons are supplied through a completely new pulping concept that ensures the specific energy is more than 30 percent lower than in conventional pulping systems.

Stephan Gruber
Chief Technology Officer,
Palm

“Thanks to Voith’s tailor-made concept, expertise and professional support, we were able to achieve and even exceed the performance targets within a very short time. In the area of sustainability, the technology takes a top position and is a good tool to further increase our resource efficiency and achieve our goals.”



2022



InfibraFiner

Resource-efficient and user-friendly refiner with the smart monitoring system.

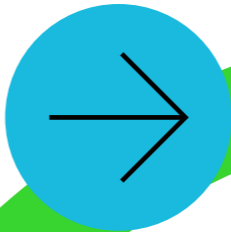

2024

Record-breaking capacity:

Sichuan Huaqiao Fenghuang Paper, China

With a design capacity of 2,200 tons a day, the BlueLine OCC stock preparation system for Sichuan Huaqiao Fenghuang Paper is the largest OCC line in the Asian market. At the Guanghan site, the BlueLine solution provides stock for the XcelLine paper machine, PM 6, which produces high-quality packaging paper in the range of 90 to 170 gsm and has an annual production capacity of about 400,000 tons. The BlueLine set-up achieves an excellent overall stickies reduction, which ensures a stable and reliable operation.

“Voith has provided us with excellent support and services. In the future, we look forward to our cooperation continuing to achieve greater success!”

Jia Tinghe
Production Manager,
Sichuan Huaqiao Fenghuang Paper

The innovations continue. The IntensaPump is the latest top-performer to be reengineered for greater efficiency, increased reliability and longer service life with the potential to reduce energy use by up to 30 percent. It is a key component of the new BluePulp LC solution.

IntensaPump

A top performer for reducing energy consumption and increasing efficiency.





By continuously prioritizing market-driven innovation, Voith ensures customers are always best equipped to capture growth opportunities. The latest upgrades to the proven MasterJet technology and NipcoFlex shoe press further enhance energy efficiency and overall performance, making the MasterJet 4Tec and HighPerformance Press two new standout innovations for the paper machine.



HighPerformance Press

Innovative upgrades for higher dry content and lower carbon emissions.



mindset
for innovations

Smurfit Westrock, a world-leading manufacturer of paper-based packaging, has committed to reducing CO₂ emissions by 55 percent before 2030. At the company's flagship Roermond paper mill in the Netherlands, innovation and continuous improvement measures support the progress toward that goal and beyond. "The best projects for us are the ones where we can actually lower our energy consumption," says Wouter Lap, Managing Director at Smurfit Westrock Roermond Papier. This is one reason why the PM 1 at the Roermond paper mill became the first-ever paper machine to install the groundbreaking HighPerformance Press solution from Voith – and with resounding success.

"After installing HighPerformance Press, we have seen a higher dry content after the press section and lower steam consumption, which helps us reduce our carbon emissions," explains Lap. But the advantages don't end there for the PM 1, which has an operating speed of 1,250 m/min, a sheet width of 5,000 mm and an annual production capacity of 275,000 tons of high-performance lightweight packaging paper with basis weights between 80 and 135 gsm. "This solution also has a cost-price benefit," Lap adds. "And it has increased our machine capacity."

HighPerformance Press

Fabrics and rolls



Press felts



Sleeves

Mechanics

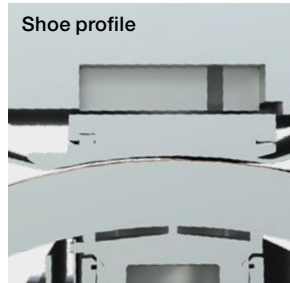

Shoe profile

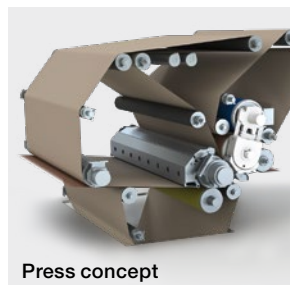

Press concept

A smart combination of press fabrics, QualiFlex press sleeves and modifications to the shoe press components ensure optimal drainage performance and maximum runability. The HighPerformance Press solution is always customized to existing conditions, such as speed range, and customer requirements.

"HighPerformance Press is a relatively easy modification with an interesting payback."

**Wouter Lap
Managing Director, Smurfit Westrock Roermond Papier**

This full range of customer benefits is exactly what Richard Horn, Global Product Manager Press Section at Voith, was aiming for when an interdisciplinary team of Voith experts first set about improving the energy efficiency and performance of the already world-beating NipcoFlex shoe press technology. As mechanical dewatering is a much more energy-efficient process compared to thermal drying, enhancing the process would reap greater benefits for customers, particularly as mechanical dewatering can be powered solely by electricity, unlike conventional thermal drying systems that still mostly rely on fossil fuels. "With our HighPerformance Press we have optimized all relevant shoe press components to make papermaking more effective and sustainable," explains Horn. At Roermond, this enabled steam consumption in the dryer section to be reduced by five to seven percent during the production of lightweight packaging paper. "A higher dry content improves machine runability," adds Horn. "Customers can also choose to take advantage of the higher dry content to speed up the paper machine by four percent, which allows an increase in production capacity. Plus, the improved press technology has the potential to save starch."

Customized modifications, maximum results

The pilot installation on the Roermond PM 1 was the final step in the intensive development process for the innovative solution. It followed tomographic scans, advanced computer and flow simulations, laboratory experiments, working prototypes and pilot machine trials at the Voith Technology Center, the company's innovation hub in Heidenheim. The whole process drew extensively on the full-line supplier expertise of Voith engineers and research and development (R&D) centers. As a result, HighPerformance Press is a finely tuned combination of modifications to the NipcoFlex shoe press and customized Voith press fabrics and QualiFlex press sleeves that work seamlessly together to achieve the desired pressure gradient for optimized mechanical dewatering. The choice of press fabrics is crucial to success as their dynamic properties impact the compression performance. Simulations show that, depending on the initial conditions, up to a three percent increase in dry content can be achieved, which reduces the steam consumption by up to 12 percent. Most notably, the new solution is easily tailored to the specific conditions of any paper machine and is quick to install. At the Roermond paper mill, the upgrade took under 40 hours and maximized mechanical dewatering functions immediately after start-up. "HighPerformance Press is a relatively easy modification with an interesting payback," Lap confirms. "It's another valuable step in decarbonizing our heat needs and achieving challenging sustainability goals."

HighPerformance Press benefits

up to
+ 3%



Increase
in dry content

up to
- 12%



Reduction
in steam consumption
in dryer section



Number of NipcoFlex
shoe presses
installed worldwide

600

Bringing headbox performance to the next level

“The MasterJet 4Tec is a big step forward in paper machine technology,” highlights Markus Häussler, Product Manager for Headboxes at Voith Paper. “After hundreds of successful installations of the MasterJet Pro, it’s time for a new headbox generation with remarkable advantages to take over.” The number four in the name has special significance. It stands for the fourth generation of MasterJet headboxes, following on from MasterJet, MasterJet II and MasterJet Pro. It also features four innovative improvements – covering formation, pulsation damping, ease of operation and energy efficiency – that set the MasterJet 4Tec apart.

Khanna Paper Mills, a leading Indian papermaker based in Amritsar and longstanding partner of Voith, is one of the first to enjoy the benefits of the new MasterJet 4Tec. As Rahul Khanna, Managing Director at Khanna Paper Mills, confirms, the MasterJet 4Tec with ModuleJet dilution technology ensures superior results on their PM 4: “We are proud to use this innovative headbox. From the beginning, the performance of the MasterJet 4Tec on our PM 4 has been impressive. The headbox delivers superior results after fast stabilization on the PM 4. This cutting-edge technology

from Voith and the positive experience by the whole team have encouraged us to place a repeat order with Voith for another MasterJet 4Tec for our PM 5, one of the widest and fastest paper machines in India to date. We trust Voith to introduce more such innovative, sustainable technologies for the cost-efficient production of paper.”

Next-level functions and operation

“For most paper grades, sheet formation is the key quality parameter, and the headbox has a significant impact on it,” explains Häussler. “In the MasterJet 4Tec, a combination of a newly designed turbulence tube and an innovative lamella concept ensures that the homogeneity of the headbox jet reaches a new level.” Compared to the already very good performance of the MasterJet Pro, the MasterJet 4Tec provides up to 50 percent improvement of fiber distribution and streak elimination in the jet. This is an excellent basis for best formation levels and perfect visual appearance of the paper.

For applications where a headbox is replaced but the existing approach flow system is retained, Voith has developed a pulsation damper for the MasterJet 4Tec that offers, no surprise, four considerable advantages. First, it features a flexible membrane that separates the air volume from the stock suspension, which avoids deposits on the tank surface. This is crucial as such deposits can come off and end up in the headbox, increasing the risk of holes in the paper sheet or even production loss due to sheet breaks. Second, as there is no diffusor plate installed, this damper creates no pressure loss, which reduces energy consumption of the headbox fan pump. Third, it does not need any cleaning showers, so there is no fresh water consumption. And fourth, it is also more compact and easier to install, even on existing machines.

In addition, the MasterJet 4Tec ensures ease of operation and clean surfaces around the headbox, which are two key topics of interest for any papermaker. “We have received



MasterJet 4Tec

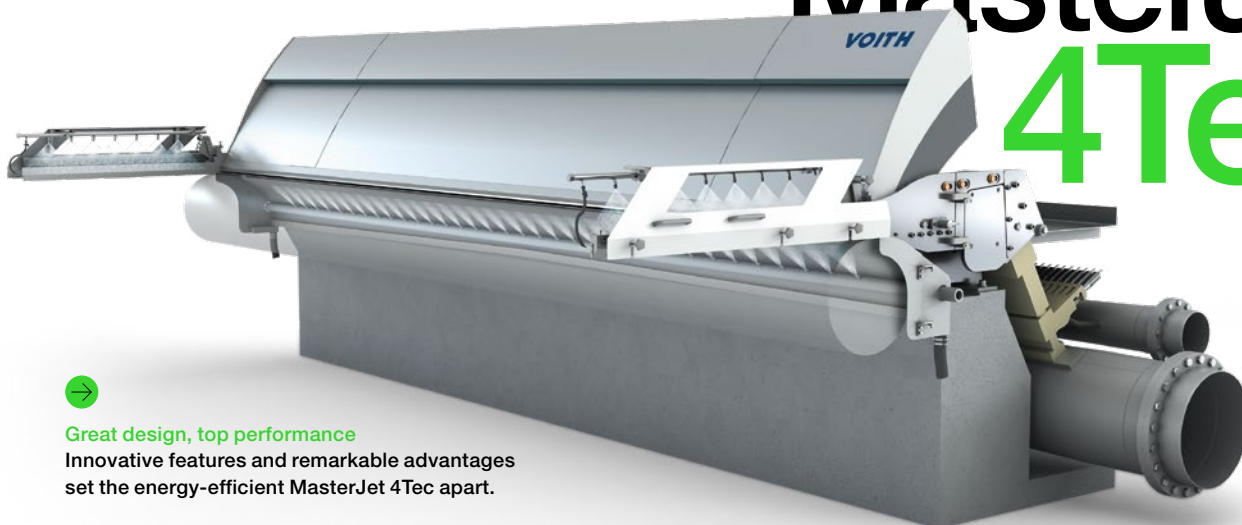

Great design, top performance
Innovative features and remarkable advantages
set the energy-efficient MasterJet 4Tec apart.

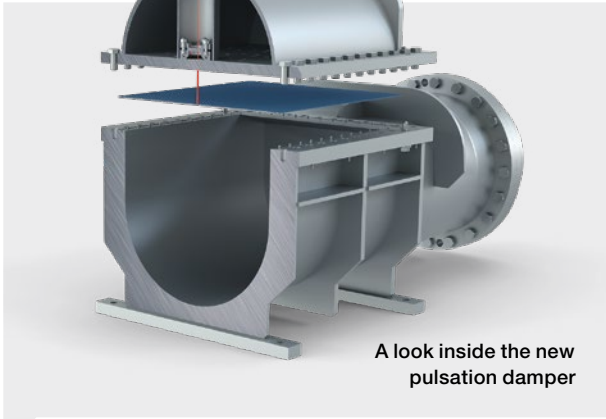

A look inside the new pulsation damper

Innovative MasterJet 4Tec damper

- **No deposits on the tank surface** – thanks to a flexible membrane that separates the air volume from stock suspension – which typically cause sheet holes and production loss through sheet breaks.
- **No pressure loss**, reducing energy consumption of the headbox fan pump.
- **No cleaning showers**, eliminating fresh water consumption.
- **More compact and easier to install**, especially on existing machines.

a lot of positive feedback from our customers regarding our previous MasterJet Pro headboxes, but still we wanted to make further improvements,” says Häußler. “We therefore focused our attention on the following during the whole development process.” One key innovation is the new EdgeMaster, which prevents the stock suspension from bleeding at the sides. The latest generation has the same innovative features as the EdgeDeckle-S (see page 4), including a new Teflon sealing concept, easy-to-adjust S-shape zones and an intuitive design. Now, it’s no longer necessary to remove the EdgeMaster when the wire is changed. The EdgeMaster is simply swiveled upwards, and, after the wire change, it is returned to the same position and no further adjustment is needed. “The new design ensures a clean wire edge and easier operation,” adds Häußler. “And it is effective in the elimination of edge waves.”

Four energy-efficiency levers and a great design

“Typically, energy consumption is not a focus topic for headboxes, but this is not right,” says Häußler. “The fan pump contributes significantly to the electrical energy consumption of a paper machine, and this depends a lot on the headbox. This is why we have put a high priority on reducing the energy consumption of the MasterJet 4Tec.”

The MasterJet 4Tec uses four levers to reduce energy consumption, which build on proven MasterJet technology. One important design feature of the previous MasterJet Pro has been further developed, namely the absence of a recirculation line on the cross distribution header. Eliminating the recirculation line leads to a 10 percent reduced flow

volume to the headbox. On top, the new pulsation damper and optimized turbulence tube reduce pressure loss at the headbox by approximately 25 percent. In one of the first installations, early experience shows that MasterJet 4Tec achieves overall annual savings of €103,000 in energy consumption.*

On top of all the functional improvements and energy-efficient features, Voith also incorporated industrial design principles into the innovation process. “From the beginning it was clear that just looking nice would be not enough,” says Häußler. “Industrial design needed to be fully integrated in the headbox development work so that we could identify a solution that combines appealing visual appearance with high functionality and value for our customers,” adds Häußler. “The excellent result is proof that it was worth the extra effort.”

* Reference: MasterJet 4Tec, 6 m wide, 1,000 m/min, 80,000 l/min, 0.12 €/kWh

Future-proofing Qw!

Continuously enhancing innovations for greater energy efficiency is one way to futureproof papermaking. Following industrial design principles is another, as Katja Benz, Product Manager Paper Machine at Voith Paper, explains.



When does industrial design enter the development process at Voith?

Katja Benz: Right from the start. Industrial design is very important in product development but also in driving innovation by integrating new materials, technologies and manufacturing processes. We improve our designs to reflect our values and fulfill the requirements of our customers and the paper industry. A well-designed machine or component can evoke positive emotions and promote enthusiasm, well-being, motivation and confidence.

Can you give a specific example?

The design, calm lines and clean surfaces of the MasterJet 4Tec show the possibilities when industrial design principles are incorporated into our innovation processes at an early stage. For example, the smooth surfaces on the MasterJet 4Tec are both functional and aesthetic. When we work with industrial design principles as a team, we constantly scrutinize existing solutions and approaches with the aim of improving them, which encourages us to break out of our usual habits and broaden our perspectives. Together, we find attractive solutions that increase the well-being of the people working in mills and make everyday working life easier.

23



Page

32

#sustainable paper making

Discover the potential of
sustainable papermaking.

Mission- Disruption

At Voith's brand-new CO₂-neutral pilot line, global teams are working intensely on decarbonizing and radically reducing water consumption across the entire papermaking process. Essity, a leading global hygiene and health company, has joined the mission to disrupt the status quo.





Elena Viviani
Technology Area Director Papermaking
and Disruptive Innovation,
Essity



Behind the huge smiles there are no doubt some serious thoughts. Standing in front of the new pilot line at the Voith Paper Technology Center, the company's innovation hub in Heidenheim, Elena Viviani takes a moment to let the magnitude of working on a breakthrough concept in papermaking really sink in. "Our dream of disrupting the papermaking process is becoming a reality with Voith," says Viviani, the Technology Area Director Papermaking and Disruptive Innovation at Essity, a leading global hygiene and health company headquartered in Sweden and producer of well-known brands including Tempo, Zewa, Tork and TENA. This is where international teams are working on an innovative papermaking process to reduce water consumption by up to 95 percent and energy consumption by up to 40 percent.

With this pilot line, which covers the entire papermaking process from raw material to winder, Voith has committed a large investment in a single research and development (R&D) project. The scope, features and flexibility of this pilot line therefore stand out. Generally, most pilot lines make compromises somewhere. Jonas Bergström, Senior Manager Disruptive Innovation at Voith Paper and Senior Lead on the pilot line, made certain this would not be the case. As Bergström highlights, the company has all the skills necessary for the success of this ambitious undertaking. Much like the construction, start-up and operation of any paper production line, over a hundred people have been involved in this pilot plant in one way or another since the project was first initiated. "No matter what specialty knowledge we need, be it automation, mechanical or process, we have what we need right here at Voith, at Essity and with our partners," Bergström says. At the same time, Bergström is able to foster a start-up culture within the project. "We have the best of both worlds," he admits. "With the incredible support of strong global organizations, we are free to experiment."

95%

Reducing
water consumption
by up to 95 percent





Applied research for the paper industry

When Viviani saw the pilot plant for the first time, it took her pleasantly by surprise. “I was astonished as it was clear that this pilot line had been designed with industrial applications in mind,” she says. “This is where we can think about what’s coming next in the real world.” The focus on real-world solutions is equally important for Bergström. “Our customized pilot line accurately replicates actual conditions in a paper mill that will allow us to work toward our goals on an industrial scale,” adds Bergström.

Driving a disruptive and complex R&D project requires balancing of many aspects, challenges and interfaces. Matthias Höhsl, Senior Manager Disruptive Innovation at Voith Paper, for instance, is the person who oversees partnerships with stakeholders. The nature of the collaboration with Essity is something that Höhsl sees as remarkable. “In what I believe was a clear sign of their trust in our expertise and innovative spirit, Essity became deeply involved in our research initiative at an unprecedented early stage,” continues Höhsl. “Essentially, we are doing industrial research together, which is an extraordinary situation in our industry. We build on each other’s strengths.”



Jonas Bergström
Senior Manager Disruptive Innovation
at Voith Paper and
Senior Lead on the pilot line

Reducing
energy consumption
by up to 40 percent



40%

Recognition for the trailblazing project

Another of Höhsl's role centers around budgets and funding. In one exciting development, the German Federal Ministry for Economic Affairs and Climate Action (BMWK) awarded the project prestigious state funding through the BMWK "Decarbonization in Industry" program, which supports projects that sustainably reduce process-related greenhouse gas emissions, and the EU "NextGenerationEU" fund. The € 14.5 million grant will be paid out over a three-year period following the successful completion of pre-defined project phases. At the official ceremony to celebrate the award in May 2024, Dr. Franziska Brantner, Parliamentary State Secretary at the BMWK, praised the pioneering venture. "The BMWK decided to fund the project because it makes a significant contribution to the decarbonization of the paper industry," Dr. Brantner said at the event. "This is a genuinely trailblazing project. The pilot plant is therefore sending out a powerful message for the Heidenheim location and the entire industry."

This powerful message is felt time and time again. For Viviani, seeing the pilot for the first time was a special moment. Another was feeling the quality of the paper produced in Heidenheim following the successful start-up in September 2023. At Essity's own research centers, the company has already started trials on converting the material into sustainable consumer products. "In many ways, we are still in the starting blocks," concludes Viviani. "But the early results are very promising. The level of commitment, cooperation and close collaboration between Voith and Essity is outstanding and it's achieving something extraordinary. We are on course to disrupt a tissue production process that has essentially been the same for centuries."



Matthias Höhsl
Senior Manager Disruptive Innovation
at Voith Paper



Disrupting the status quo together:
the new pilot line at the
Voith Paper Technology Center

Future- proofing

Having repeatedly invested heavily in successful R&D initiatives, Voith is no stranger to developing future-oriented innovations or pilot plants. International teams are therefore used to rethinking long-standing processes to meet the changing needs of customers and society. For instance, at the world's most modern pilot coater in Heidenheim, domain specialists are working closely with customers to develop 100 percent renewable flexible packaging. At the Fiber Technology Center, which is right next door, the recyclability of these paper packaging solutions is tested. Now, thanks to the combined expertise of Voith, Essity and Toscotec, this brand-new pilot line is set to disrupt traditional papermaking processes and make CO₂-neutral papermaking possible. It is taking the industry a step toward a greener future for papermaking.

The trailblazing project is to receive prestigious funding through the BMWK "Decarbonization of Industry" program and the EU's "NextGenerationEU" fund.

Supported by:



Federal Ministry
for Economic Affairs
and Climate Action

on the basis of a decision
by the German Bundestag



Funded by
the European Union
NextGenerationEU

A recipe

1

for success



Equipped with an efficient system of tension control: the OPTIMA Winders NW.

Voith and Toscotec offer the most advanced end-to-end solution for the sustainable production of biodegradable wet-laid nonwovens from 100 percent renewable raw materials. Meet the two experts behind the full-line supplier approach.

Watch the animation of the complete end-of-line section from Toscotec.



Oliver Crasser: Together, we now offer a unique full-line supplier solution that will ensure our valued customers can produce the sustainable types of wet-laid nonwovens – or hygiene wipes – that are increasingly in demand. At the front end, a key component for wet-laid/spunlace machinery is the Voith HydroFormer. Now, Toscotec technology is available for the end section. Massimiliano, what can you tell us about this latest innovation from Toscotec?

Massimiliano Corsini: You could say that we built on the success of Voith in nonwovens and our technological expertise in tissue to provide the missing piece to the sustainable wet wipe puzzle: the complete end-of-line section. The project is focused not only on wet wipes but also on the various types of nonwovens on the market today.

Oliver Crasser: This is a critical phase in the manufacturing of nonwovens. How will our customers benefit from the Toscotec end-of-line section?

Massimiliano Corsini: For wet-laid nonwovens, our customers need technology that preserves bulk and ensures accurate tension control of the product, which is very delicate. And this is what we now provide.

Oliver Crasser: This reminds me of how Voith entered the market: we took the established HydroFormer and successfully adapted this technology for a completely new business area. Is there one technology in your portfolio that plays a similar role?

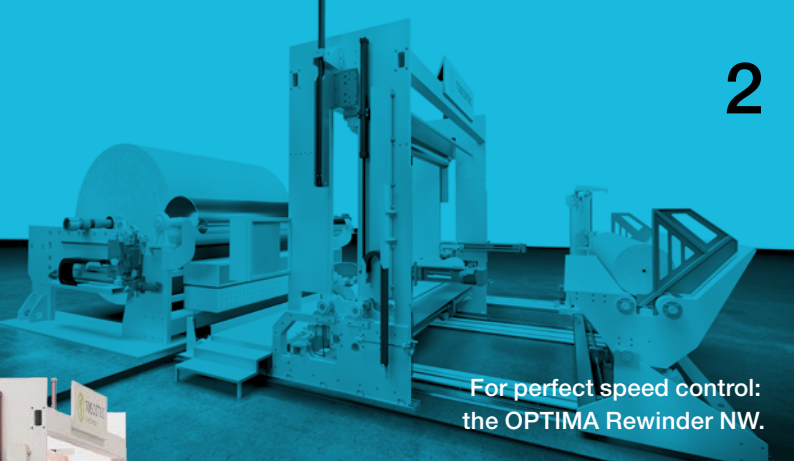

For perfect speed control:
the OPTIMA Rewinder NW.

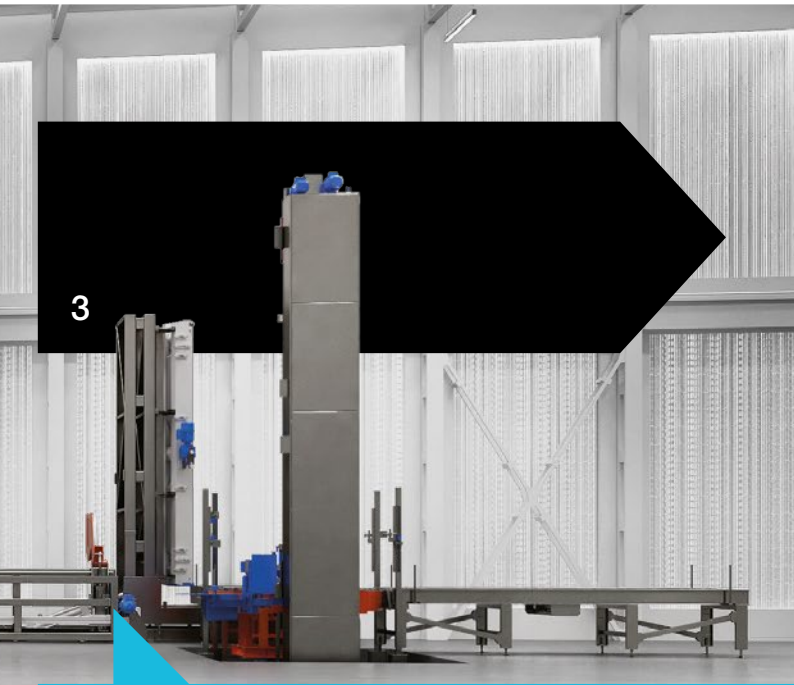
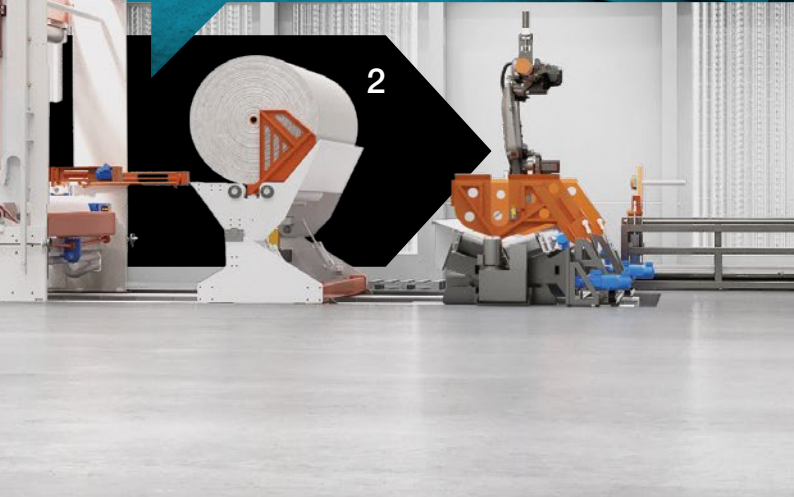

Fully customizable:
the OPTIMA packaging system.



Massimiliano Corsini: There are three, in fact. Our end-of-line section consists of the OPTIMA WinderNW, the OPTIMA RewinderNW and our best-in-class packaging solutions. Each is designed to preserve high product quality, high efficiency and high production capacity. Our winder offers superior nip and tension control, while the rewinder has an automatic nip control system that detects and adjusts the thickness and bulk of the wound reel in real time. Naturally, our packaging solutions are fully customizable to our customer's production goals and available space.

Oliver Crasser: It sounds like a recipe for success, Massimiliano!

Meet the experts

Oliver Crasser joined Voith Paper in 2007 and is now Sales Manager for Nonwovens, along with Dietmar Sporer. Based in Düren, Germany, his expertise lies in providing customer-focused sustainable solutions for manufacturers of this specialty material. Essentially, Toscotec's customized end-of-line solution for nonwovens is the brainchild of Massimiliano Corsini. The Business Development Director has worked in the industry for over 30 years and is based at the company's headquarters in Lucca, Italy.

Massimiliano Corsini
Business Development Director, Toscotec
Oliver Crasser
Sales Manager, Voith Paper



Future-proofing !

Together with long-term partners, Voith developed a breakthrough concept to produce plastic-free, biodegradable and certified flushable wet wipes from 100 percent renewable raw materials – using less fresh water. It has already been installed in more than 10 production lines around the world. Toscotec has developed an innovative end-of-line section to complete the full scope of delivery for producers of wet-laid (spunlacing and carded pulp) nonwovens and all nonwovens that need to preserve bulk and mechanical characteristics.

In the

Virgin resources

Yarns production



The latest advances in recycling and bio-based materials are helping to shrink the carbon footprint of the wear parts for the press section, thanks to a combination of closed-loop recycling initiatives, low-carbon production sites and a passionate team of innovators.

Fibers
production

Yarns

Fibers

Press felt
production

Press felt

Press felt life cycle

Following circular economy principles
offers a new life for press felts.

“Our goal is for the press section to have as little impact on the environment as possible,” explains Lidia Loskan, R&D Project Manager Sustainability at Voith Paper. “So, we are tackling the carbon footprint on multiple fronts.” Alongside designing energy-efficient, high-performance machinery and wear parts comes designing out waste in ways that benefit customers and the planet.

In one initiative, the number one priority is to bring circular economy principles into the whole life cycle of press felts. “To offer fully recycled and recyclable products, press felts need to be part of an infinite closed-loop process,” says Loskan. “But this takes time.” In a close partnership with Aquafil S.p.A., a leading expert in sustainable production, Voith is ramping up the use of recycled material in press felts and trialing the recycling of used press felts from customers and unavoidable waste from Voith’s production sites. The recycled yarns are used to produce press felts at Voith’s low-carbon production site in Högsjö, Sweden. Initially, the target is to use hundreds of tons in yarns each year. “It’s no easy task,” admits Nicole Soligo, EP ECONYL® Product Manager at Aquafil. “We’re proud to be working with Voith to create a closed material loop for press felts.”

“It’s a winning
combination for us.”

Robin Linney
Plant Manager,
Palm Paper, King’s Lynn

Customer-focused sustainability

Customers who join the scheme receive a certificate confirming their commitment to recycle waste. Using recycled yarns in new press felts also supports customers in their sustainability measures. Compared to yarns from virgin materials, yarns from 100 percent recycled material cut CO₂ emissions by 80 percent. “Our customers appreciate every effort we make to reduce the carbon footprint of their paper mills,” confirms Anders Nord, Product Management Press Section EMEA at Voith Paper.

Why press felts? As Loskan explains, of all the fabrics used in papermaking, press felts have the greatest potential to be made from recycled material – and to be recycled efficiently and infinitely. First, it’s cost-efficient to recycle monomaterials, and the Voith press felts are mainly made from a single type of material. Second, the infrastructure for the chemical recycling of this material is already in place. “A mechanical recycling process physically breaks down used press felts, and yarns made from that material have reduced strength and properties. However, with chemical recycling, the recycled yarns retain the same properties as yarns made from virgin material,” says Dr. Robert Eberhardt, Senior R&D Manager at Voith Paper. “Our customers can be confident that our press felts produced with recycled fibers will offer the exact same high performance as conventional press felts.”

SolarFlow Green

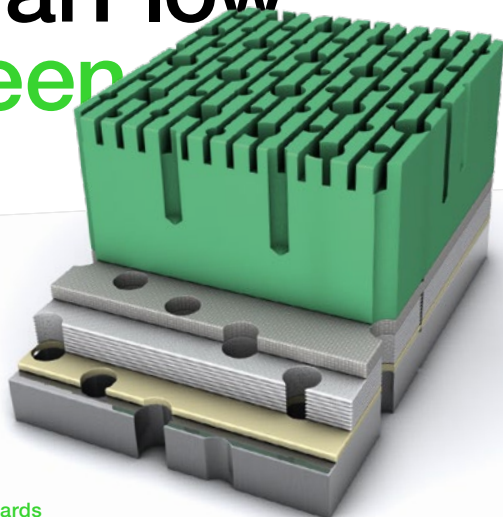

Setting standards

All the advantages of the proven SolarFlow technology with bio-based materials.

Bio-based ambitions and successes

Similarly, the focus is on product performance in another ambitious sustainability initiative for the press section. This time, the R&D team has succeeded in manufacturing the first-ever DIN CERTCO-certified suction press roll cover made with bio-based materials. The team built on the strengths of the popular SolarFlow, Voith's high-capacity suction press roll cover, to develop SolarFlow Green, which is produced with between 20 and 50 percent bio-based materials at Voith's low-carbon production site in Wimpassing, Austria. In another first for the industry, SolarFlow Green has been certified by DIN CERTCO of the TÜV Rheinland Group, an independent organization specialized in the certification of bio-based materials.

"We started with a roll cover that has to withstand the harshest conditions in the paper machine, knowing that if we can make it work here, bio-based materials can work anywhere in the press section," notes Dr. Christina Bauer, Global Product Manager Press Roll Covers at Voith Paper. "This is therefore an important milestone in sustainable papermaking for our customers." But Voith's ambitions don't stop there, as Christine Rinner, Material Expert at Voith Paper, points out: "We are already working on the next step, which is to increase the proportion of bio-based materials to over 50 percent."

The bio-based suction roll cover is already proving its worth, as Robin Linney, Plant Manager at Palm Paper, King's Lynn in the UK, confirms. "Achieving a high dry content is extremely important to us," says Linney. "Thanks to SolarFlow Green, we were able to implement our customized surface design, resulting in maximum dewatering in the press section. We achieve this using resource-friendly, sustainable materials. It's a winning combination for us."

Key principles of circularity

- Designing out waste
- Extending the product life cycle
- Improving material efficiency
- Recycling in a closed loop
- Using bio-based materials

Future-
proofing 

In parallel to the exciting R&D milestones, Voith continues to lower the carbon footprint of the production sites for sustainable wear parts. For instance, the Högsjö plant for press felts in Sweden is partly powered by a hydropower plant. In Wimpassing, Austria, where the SolarFlow Green is manufactured in the state-of-the-art hub, plant-wide photovoltaic installations generate over 274,000 kWh of electricity annually and a heating optimization project saves 379,000 kWh per year. Both plants have switched to efficient LED lighting in many areas. In addition, Voith is looking in all directions to reduce the carbon footprint of the wear parts, including by exploring more resource-efficient logistics and transportation options.

33

Page



43



#efficient papermaking

Discover the potential of efficient papermaking.

Future(s) unfolding



A framework for the future:
Voith focuses on creating
a culture of open and transparent
collaboration and innovation.

Increasing autonomous operations along the paper production line offers exciting prospects for business profitability, workforce empowerment and sustainability gains. Voith has the unique expertise to kick-start the process to the autonomous paper mill and support customers with best practices along the entire journey.

“In many ways, the journey to the autonomous paper mill is very similar to the one up a challenging mountain,” says Ulf Grohmann, Director Product Management Autonomous Mill at Voith Paper. If your goal is to reach the top, he explains, you need to know what equipment to take, which paths to follow and what risks to expect. Most importantly, you need a guide that has the skills, stamina and survival skills to reach that goal. “You wouldn’t think twice about the need to prepare for the journey up a mountain,” adds Grohmann. The potential returns make the preparation worthwhile. The same is true in papermaking.

Building blocks to the future

Three building blocks enable successful data-driven papermaking.

Degree of automation:

- Which processes are automated?
- Which are manually operated?

Availability of data:

- How is data collected, accessed and used?
- Is the data consistent?

Organizational maturity:

- Are industry best practices followed?
- Is there a structured approach to continuous improvement?
- What skills do operators have and use?
- What is the culture in the organization?

According to Bain & Company’s influential Global Paper & Packaging Report 2023, best-in-class mills that are technology-driven can raise EBITDA by a seven percentage-point margin or more. Similarly, McKinsey estimates that manufacturing industries could significantly boost productivity if companies made better use of technology to share expertise across a plant and beyond. A more collaborative maintenance process, for instance, allows fast access to specialist knowledge and tried-and-tested solutions as well as better prioritization of tasks. As this approach improves plant health and minimizes downtimes, the consultancy firm notes, overall equipment efficiency could potentially enjoy a boost of two to three percentage points. “The autonomous paper mill empowers the workforce to do their best work and it drives economic growth,” says Grohmann. “What’s more, it’s a place that respects and protects our planet.”

The flexible framework

Voith has developed a flexible framework for implementing and increasing autonomous operations. The process is rooted in the principles of design thinking, which fosters collaborative, user-centric and value-enhancing problem-solving, and Kaizen, the Japanese philosophy that promotes continuous improvement through incremental change. “Our goal is to create an environment where everyone is working together on continuous improvement to impact the bottom line in a fully transparent process,” says Grohmann. As each customer works in unique situations with their own priorities, this framework is designed to be flexible. What each journey has in common, however, is the first phase of the journey, or the kick-off.

Kick-off

This phase is essential for understanding the starting point, determining goals and establishing a firm base of best practices for customers. It’s a time for probing questions around the three key building blocks that Voith has identified for successful data-driven production, namely the degree of automation, data availability and organizational maturity. During tailored workshops, Voith specialists in automation and process technology first explore the status of these building blocks with customers and assess how they align with high-level targets and organizational strategy. “A workshop may start with customers expressing a concrete goal, such as to increase production capacity or reduce overall energy use,” explains Grohmann. “Our sessions and audit activities then drill down into the building blocks. We look at everyday tasks, processes and procedures to first understand why those targets are not already being met. Using our knowledge and experience, we identify what action can be taken together to change that.” Out of these sessions, a customized roadmap for the future is co-created.

“The goal is to create an environment where everyone is working on continuous improvement to impact the bottom line in a fully transparent process.”

Ulf Grohmann

Director Product Management Autonomous Mill,
Voith Paper

The workshops are an opportunity for customers to explore how a more transparent, data-driven working environment supports open collaboration and teamwork, which in turn would positively impact productivity and resource efficiency. This is true for the process manager and operators, who keep an eye on multiple complex processes, machinery and tools at the same time and react appropriately in a timely way. It's the same for the mill manager, who needs instant access to the right kind of data to support instant decision-making and task allocation to the team from any location and to see that the mill is performing well. Often, this kick-off phase underlines just how much the skills needed at the mill have changed over time – and how attractive a workplace a data-driven paper mill is becoming.

Value creation

“Next, we introduce proven technologies in phases to demonstrate the tangible value of autonomous operations,” says Grohmann. This can range from closed-loop production processes to boost efficiency or solutions that allow sections of the plant to essentially run without operators. For leading papermakers, Voith is already developing systems that automatically assign tasks to people based on roles, situations, timing or even process events in a way that supports continuous improvement. The goal is to create transparency and empower people in their roles to make better, data-driven decisions and lift operations to the next level. This in return frees up capacity to develop their organization even further.

As additional processes are evaluated and the level of autonomy at the mill increases, roles and responsibilities will invariably change. “In parallel to working on the technology, we work together with our customers on transforming the workplace culture, particularly by training teams to use new machinery and develop troubleshooting skills,” adds Grohmann. This is a critical success factor. By demonstrating the concrete benefits of implementing autonomous processes, operators, process managers and mill managers can get on board with the transformation early on. And as paper mills introduce more sophisticated digital and automation solutions and apply them across the whole operation, they see how the benefits increase.



Value creation



Consultancy & Management

- Implementing, evaluating and prioritizing solutions
- Creating stable processes
- Improving machine availability and efficiency
- Enabling data-driven decision-making





Continuous optimization

Advanced Controls & Process Automation

- Ensuring ongoing cost optimization
- Reducing energy, water and fiber consumption
- Targeting bottlenecks and using best practices, such as the golden run
- Securing operational excellence



Continuous optimization

Once customers are enjoying a more stable, robust paper production process, they move on to the next phase within Voith's framework. Essentially, this is an ongoing, never-ending process that focuses on continuous optimization and resource efficiency. "This is perhaps the most exciting of all phases," says Grohmann. "Now, we've entered a continuous loop of setting targets and defining appropriate measures. At the same time, we can search for additional value that had not been prioritized in the beginning and can now be lifted with other solutions. In a way, this is a permanent, ongoing iteration process that creates, implements and continuously optimizes new ideas and solutions."

To successfully transform a paper mill into a smart, data-driven operation, there's not just one ingredient, but many, including effective leadership, clear communication and open collaboration between teams. State-of-the-art machinery, cutting-edge sensors and advanced process control tools for the highest level of automation all have a role to play. "Whatever mountain our customers are trying to climb, we support them with the necessary value-adding solutions along the entire journey," concludes Grohmann. "We ensure our customers get where they need and want to be at every step. We turn climbing a mountain into a long walk in the park. So, let's get started and see how we can bring value for you."

Future-proofing !

Highly automated processes have the potential to stabilize and optimize operations, thereby freeing up operators and process managers for more value-adding tasks. Process managers will be able to keep an eye on production performance while also being proactively informed of potential areas that could be immediately improved. At the same time, autonomous operations cut out many of the more stressful elements of mill management and allow the mill manager to work remotely.



Discover the benefits of the autonomous paper mill and get in touch to kick-start the journey.

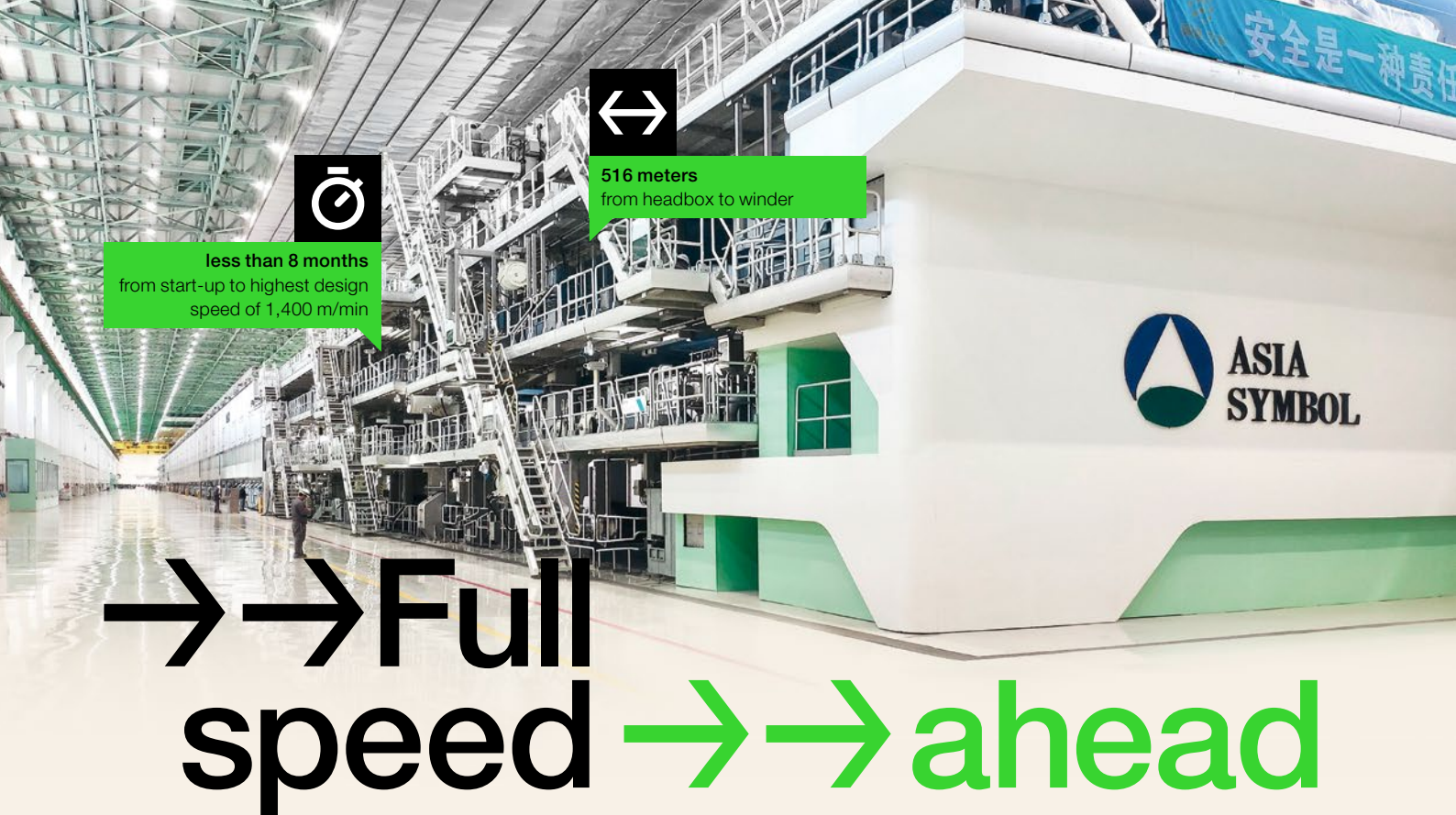

less than 8 months
from start-up to highest design
speed of 1,400 m/min



516 meters
from headbox to winder

→ → Full speed → → ahead

Asia Symbol and Voith achieved the highest design speed breakthrough with Rugao BM 13 in record time, cementing Asia Symbol's competitive edge and sustainability drive.

To get a sense of the record-breaking size, speed and efficiency of Asia Symbol's BM 13 in Rugao, China, Olympic comparisons are necessary. With a total length of 516 meters from headbox to winder, Rugao BM 13 is almost one and a half times the size of the iconic Beijing National Stadium (the Bird's Nest), which hosted the 2008 Summer Olympics. What's more, the Rugao BM 13 achieved the highest design speed of 1,400 m/min in just under eight months after start-up, that's a record of Olympian scale for the paper industry.

"The cooperation with Voith has opened a new chapter in the Chinese paper industry," highlights Jigang Xia, Operations Director at Asia Symbol (Jiangsu). "A white folding boxboard machine with a speed of 1,400 m/min after a start-up time of only eight months is a global benchmark! We are very grateful to the Voith team for their professionalism and tireless efforts. The close cooperation between the two teams has enabled us to set new standards in production quality and efficiency."

For René Bauer, Project Manager at Voith Paper, the successful team effort is also a source of great pride. "We are very proud of the coop-

eration with Asia Symbol," he says. "The unwavering commitment to technological advancement and efficient production is a shared goal of both teams." As a full-line supplier, Voith's scope of supply covers the entire production line, from the BlueLine stock preparation line to the two VariFlex Performance winders, which are essential for high-speed production and high machine availability. The centerpiece is the ultra-modern XcelLine paper machine. It has a width of 8,160 mm and an annual production capacity of around one million tons of high-quality white folding boxboard with a basis weight range between 170 and 400 gsm. Entrusting the project to a full-line supplier is a crucial success factor, as Joachim Huber, Sales Manager at Voith Paper, underlines: "This project with Asia Symbol has once again demonstrated our value as a reliable partner for our customers."

Reaching the highest design speed in record time is one important achievement for the Voith and Asia Symbol teams, as Carlos Lin, Order Execution & Operations at Voith Paper China, is keen to stress, but there will be others. "We will continue to be committed to providing our customers with advanced and reliable solutions that help them maintain their competitive edge in the market and drive the further development of the entire paper industry."



To improve resource efficiency of BM 13, Voith supplied an energy-efficient EcoHood dryer hood and contactless qDry Pro drying concept that uses the HelioX high-performance infrared emitters as well as the resource-saving Triple NipcoFlex press. A wide range of automation solutions ensures the production line runs at full speed and capacity, including OnControl MCS, DCS, Drive Control, OnQuality MD/CD Control and the OnCare Health condition monitoring system, which enables predictive monitoring of the production line. Combined, these proven innovations ensure maximum machine availability and efficiency for Asia Symbol.

A sophisticated conversion rebuild for Shandong Huatai Paper heralds a new phase in high-quality graphic paper in Asia.

Shandong Huatai Paper
Huatai PM 11

China
Shandong

The trendsetter

Shandong Huatai Paper, one of the world's leading manufacturers of newsprint, is setting new standards in high-quality graphic paper for Asia following the customized rebuild of the PM 11. "Our sophisticated rebuild has transformed a former newsprint paper machine into a modern centerpiece of Huatai's production line," notes William Wang, Senior Project Manager at Voith Paper China. This rebuild in the eastern Chinese province of Shandong is part of a series of successful conversion rebuilds and new line start-ups during the long-standing strategic partnership between Voith and Huatai. Ray Xiao, Sales Manager at Voith, adds, "Voith is proud of our 30-year partnership with Huatai. Our collaboration has been highly successful, and we look forward to continuing our fruitful cooperation in the future."

"After the rebuild of PM 10 from newsprint to graphic paper in 2016, the successful start-up of PM 11 represents a significant milestone in Huatai's transformation process to high-quality graphic paper," confirms Wei Lijun, General Manager of Shandong Huatai Paper. "The rebuild has not only transformed the almost 20-year-old paper machine into a modern paper machine but has also significantly improved the machine's stability and capacity."

The PM 11 has an interesting past as well as a promising future. Huatai purchased the paper machine in 2001. The Huatai PM 11 was designed to produce high-quality smooth newsprint paper, allowing many news organizations in Asia to print color photos and images in their newspapers. This set off a popular trend across the region, remembers Wang, who was also involved in the successful

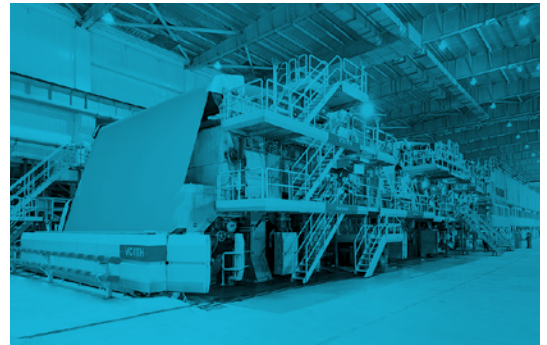

Huatai PM 11:
a sophisticated rebuild for high-quality graphic paper.

rebuild and 2001 start-up of the Huatai PM 11. "Huatai was a trendsetter then," says Wang. "And the company is still a trendsetter today."

This time, the Huatai PM 11 is expected to set standards in high-quality graphic paper across the region. In terms of both hardware and software, the PM 11 will remain highly advanced.

The customized rebuild includes state-of-the-art machinery and digital and automation solutions from the Papermaking 4.0 portfolio to boost stability, reliability and efficiency. Particularly, the OnQuality quality management system (QCS) and the OnControl automation technology (MCS) will bring a significant increase in operating convenience and control stability. Kurt Yu, President Asia at Voith Paper, is especially proud of the results. "This cooperation not only demonstrates our customer's confidence in Voith's technological excellence but is also the highest compliment in our 30 years of cooperation in terms of mutual trust and synergy." Both companies see more opportunities for the partnership, as Wei confirms, "We look forward to writing more success stories with Voith in the future."

Future-proofing 

Voith performed extensive upgrades on most sections of the Huatai PM 11 to improve machine availability, minimize paper breaks and reduce energy costs. The customized scope of supply covers the upgraded MasterJet Pro G headbox, optimized dilution water technology, ProRelease+ HighEnd boxes in the pre-dryer section, as well as the CombiDuoRun dryer concept and an efficient new dryer section hood in the after-dryer section. In addition, a combination of a SpeedSizer AT and Voith's roll covers ensures even and high-quality paper profiles, optimum sheet release and reduces paper breaks.

The full cycle

- 1 Kick-off**
Clear alignment on scope of maintenance from the outset ensures precise planning.
- 2 Planning**
Comprehensive cost-effective planning optimizes resources, minimizes downtime.
- 3 Technical alignment**
Collaborative approach ensures tasks and responsibilities are clear.
- 4 Management**
Continuous oversight enhances safety, efficiency and availability of resources.
- 5 Shutdown execution**
On-site presence ensures smooth execution, fast trouble-shooting and efficient decision-making.
- 6 Technical report**
Detailed insights improve proactive maintenance and future planning cycles.
- 7 Lessons learned**
Follow-up analysis refines maintenance strategies and promotes continuous improvement.

Voith's planning cycle ensures the management and execution of the annual maintenance shutdown for Klabin is safe, smooth and on schedule and brings added value to the paper mill.

Every year, Klabin, the largest producer and exporter of packaging paper and sustainable solutions for paper packaging in Brazil, welcomes a 100-strong team of Voith engineers into its facilities in Telémaco Borba, Paraná, Brazil. During the yearly mill-wide 10-day total shutdown, Voith conducts the annual maintenance on the PM 9 at the Monte Alegre Unit. The comprehensive service, which is always meticulously planned in close cooperation with Klabin over a 15-month period, consistently improves machine availability and performance. "The annual maintenance shutdown is a major event in Klabin's calendar," explains Luiz Francisco Almeida, Engineering and Maintenance Planning Manager at Klabin. "Thanks to Voith's in-depth knowledge of the PM 9, we can trust Voith to carry out the maintenance work in an utmost safe, reliable and efficient way. They have the full-line supplier competence to ensure the paper machine is always fit for the future."

Since 2007, Voith has planned, organized and carried out the full annual maintenance for the PM 9, which has a design width of 7,300 mm, a design speed of 1,000 m/min and a production capacity of 1,500 tons of liquid packaging board per day. "The annual maintenance is an incredibly complex undertaking," says Elivaldo Silva, who is the Head of Services South America and Operations at Voith Paper, Brazil. "We therefore follow a precise planning cycle that is designed to ensure the maintenance, repairs and

inspection checks run smoothly and bring the added value that our customers appreciate." This cycle also covers detailed manpower planning and the spare parts delivery schedule to ensure that the right specialists are at the right place with the right spare and wear parts during the shutdown. "As a full-line supplier, we cover every section of the paper machine and every papermaking process," highlights Silva.

For Klabin, the annual shutdown maintenance package includes services, spare parts, wear parts and consumables, and refurbishment for proactive and preventive maintenance. "Voith expertly organizes, manages and implements the annual maintenance shutdown for the PM 9," adds Almeida. "Every day, every activity is precisely timed and carried out. It's impressive to watch."

Voith's commitment to long-term partnerships, extensive in-house knowledge, full-line supplier expertise and deep understanding of the entire production site's history ensure a trusted, collaborative working environment and tailored support. Every shutdown maintenance therefore maximizes machine uptime, minimizes maintenance costs and ensures customer satisfaction.

Future-proofing 

For Domtar in the U.S., CONTROLsuite provides the essential tools to better understand, fine-tune and automate the control systems.

To solve a problem, it first needs to be identified. This is exactly what CONTROLsuite is reliably doing at the Domtar Rothschild Paper Mill in the U.S. state of Wisconsin, where premium specialty paper is produced. "In Domtar's manufacturing plants, automation is a way of life," explains John P. O'Donnell, Director Fiberline Optimization at Domtar. "The CONTROLsuite software has provided us with visual aids to better understand the status of many control systems. The tool also empowers our process engineers to learn, monitor and tune loops identified for attention. This software is a very sound product helping us improve daily."

In a nutshell, CONTROLsuite is an advanced, cost-effective toolbox for monitoring, evaluating and fine-tuning the thousands of loops that control every process parameter running simultaneously in a mill. By ensuring the continuous performance monitoring of all individual process loops across the entire pulp mill, CONTROLsuite pinpoints underperforming loops and also helps identify the root

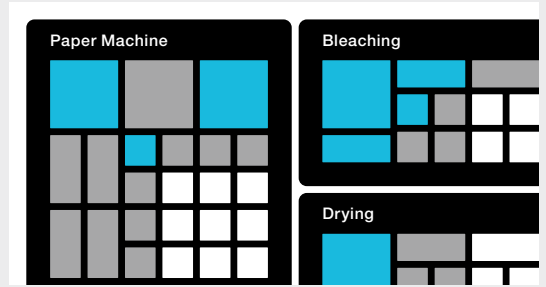

Flexible, intuitive, essential: the loop monitoring platform maximizing performance.

causes of many issues, such as high water or energy consumption that may be the simple result of a loop that is not in its preferred mode. CONTROLsuite also delivers user-friendly daily reports that visualize loop performance and weaknesses in a comprehensive way, highlighting disturbance, oscillation and actuator performance. Once CONTROLsuite has identified the root causes, process engineers can prioritize the best course of action. If an issue is mechanical in nature, maintenance teams can repair the issue on site. If tuning is the problem, CONTROLsuite has that covered, too. The platform includes an intuitive tuning tool with built-in modeling functions that can calculate new tuning parameters, which restores the loop to optimal levels of performance. "Without CONTROLsuite, it's a challenge to determine which loops are not operating efficiently – or what actions need to be taken to restore high performance," explains Jason Briggs, who is a member of the team that is developing CONTROLsuite in North America.

Fine-tuning the mill



1–2%
Potential reduction
in energy consumption

4–8%
Potential increase
in productivity

Future-proofing 

Papermakers are losing hundreds of thousands, potentially over a million at larger sites, every year because of untuned control loops. These loops, numbering in the thousands, are crucial for optimal paper mill performance, as they manage every process parameter within each process area. When these loops are not properly tuned, mills become inefficient, leading to increased water and energy consumption, the overuse of chemicals and therefore substantial additional costs. By implementing CONTROLsuite, pulp and paper mills can fully optimize their energy and raw material usage, maximize production and increase process stability with enhanced product quality.



Discover how CONTROLsuite supports customers in achieving sustainability and productivity objectives more efficiently.



Future-proofing w!

Yangi's 3D-formed cellulose-based packaging technology significantly reduces CO₂ emissions (-70 percent compared to plastics production) and energy consumption (-75 percent compared to wet molding production). The dual focus on energy and resource efficiency supports Voith's Papermaking for Life sustainability program and the goal of achieving 100 percent CO₂ neutral paper production by 2030.

In 2022, Voith invested in Yangi, the Swedish start-up that has perfected a turnkey dry forming manufacturing technology for 3D-formed cellulose-based packaging. The Yangi founder and CEO share their views on how their innovative approach is set to revolutionize sustainable packaging.

What's so groundbreaking about the Yangi solution?

Anna Altner: It's a totally disruptive turnkey solution. Although dry forming technology has been around for a while, through intense R&D over a period of more than 10 years we've perfected it. Today, our solution covers the complete machinery, process engineering, consultancy, service, material supply and more.

Johann Kaiser: Our 3D-formed cellulose-based packaging solutions that are manufactured with our process and machinery are set to revolutionize packaging. In a nutshell, we make it easy for brands and packaging producers to switch to more resource-saving, cost-efficient, renewable and 100 percent recyclable packaging.



Attractive option: the packaging stands out for its low environmental impact.



The success at Yangi is very much driven by your start-up mindset. How does the partnership with Voith support that innovative culture?

Johann Kaiser: We have common goals and motivations. Both companies are passionate about making a positive impact on our society. We strive to offer futureproof solutions to ensure that packaging producers can seamlessly move into sustainable packaging. In our case, we are focused on a specialized area: the dry processing of fibers into high-quality, renewable packaging. By joining forces with the leading full-line supplier in the paper industry, we gain the support of an established and respected industry expert. Obviously, the financial investment has been a huge boost for our business development and R&D. More importantly, however, through the Voith global network, we gain crucial new insights into the supply chain of the packaging industry and have access to Voith's vast industry expertise and experience in papermaking, sales and aftermarket services.

Anna Altner: At the same time, we know that our start-up mindset is highly valued at Voith. By maintaining a very hands-off approach, Voith also helps us stay agile and able to respond rapidly to new circumstances and market demands. Our start-up mentality supports the innovative culture at Voith. So, we profit from each other and inspire each other. This partnership is an excellent fit that will lead to a faster roll-out and take-up of our breakthrough technology.

What does the future hold?

Anna Altner: The demand for fiber-based packaging is no longer a trend, it's a sustainable revolution. Brands are increasingly aware of the role that sustainable packaging plays in delivering what the customer wants – and what is needed to help mitigate climate change. With Voith, we expect to collaborate more closely on innovative, resource-efficient solutions that cover the entire packaging value chain, from raw materials to the final packaging. It's an exciting time to work together for a sustainable way forward.

Johann Kaiser: Our nature is flooded with plastic waste. But the tide is turning. Legislation on the use of plastic packaging is getting stricter. Extended producer responsibility (EPR) fees are on the rise. The fiber-based packaging materials that are produced with our know-how offer a sustainable alternative to replace rigid plastic at scale. We're taking action with Voith to secure a sustainable future.



Anna Altner
Founder &
Head of Strategy &
Investor Relations,
Yangi



Johann Kaiser
CEO, Yangi



The next-generation solution

The Yangi solution produces 100 percent renewable and recyclable packaging from sustainable forests without dissolving fibers in water.

AUTONOMOUS
PAPER MILL



Future(s) unfolding

Imagine a greener mill, where automation technologies optimize resource consumption – ensuring sustainable and regulatory-compliant operations.



Explore the
mill of the future!

VOITH