

Remote mounted arrangement Highly flexible K Coupling



Advantages and benefits

- + Shifts resonance frequencies into non-critical speed ranges
- + Ensures a high degree of operational durability
- + Standardized components ensure an optimal cost/benefit ratio
- + High torque capacity

K Couplings for remote mounted arrangements are specially designed for applications where driver and driven machines are installed on different foundations and located relatively distant from each other. The driver and the driven machines are then connected via a joint shaft.

The K Coupling shifts resonance frequencies below idle speed and dampens torsional vibrations and shock loads. As a result, operational stability and thus productivity of your system or vehicle increase.

Furthermore, the highly flexible coupling supports the weight of the joint shaft, guiding and stiffening it radially. Thus this coupling type is ideally suitable for rail vehicles, construction machinery and engine test rigs. Depending on the size, up to 1 300 000 Nm can be safely transferred.

We offer two different coupling designs for the remote mounted arrangements according to size and length of the joint shaft:

Universal joint shaft couplings

- The bearing which guides the joint shaft is integrated into the coupling design.
- The weight of the joint shaft and coupling is transmitted to the rear crankshaft bearing.
- Depending on the coupling series, friction or antifriction bearings are used.
- These bearings follow any relative twist of the coupling performing an oscillating rotary movement. This is considered both in the bearing design and in the selection of the bearing materials.

Outrigger bearing couplings

- The coupling comprises of a bearing system for bell-house mounting if the crankshaft bearings of the diesel engine cannot support the weight of joint shaft and coupling.
- The bearing is located inside a bell-housing which is bolted to the engine flywheel housing.
- The weight of the joint shaft is transmitted to the engine flywheel housing.
- The bearing does not carry out a vibrating rotation, it rotates with the joint shaft, and for this reason needle roller bearings are used.

Remote mounted arrangement

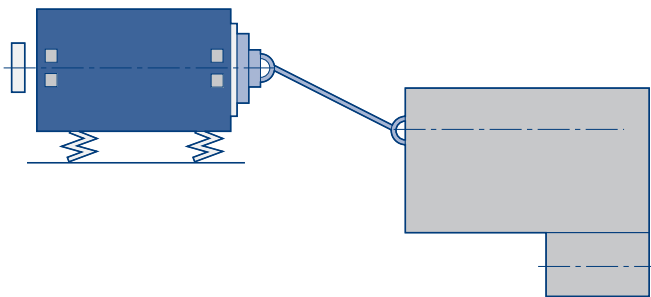

Universal joint shaft coupling

Series 152

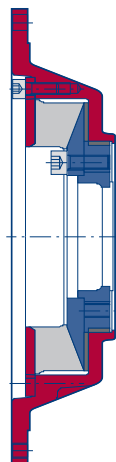

Outrigger bearing coupling

Series 142

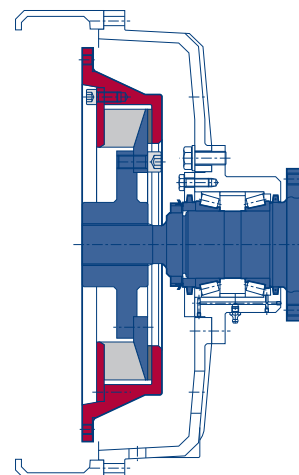

Product range highly flexible universal joint shaft couplings

Designation	Type of coupling	Bearing type	Frictional damping	Connection	Notes	Page
BR 150	Centred single element coupling	Friction bearing	yes	Engine flywheel – joint shaft	Very short installed length	4, 14
BR 151	Centred single element coupling	Antifriction bearing	yes	Engine flywheel – joint shaft	For higher speeds	4, 15
BR 152	Centred single element coupling	Friction bearing	yes	Engine flywheel – joint shaft		4, 16
BR 153	Centred single element coupling	Antifriction bearing	yes	Flange – joint shaft	For higher speeds	4, 17
BR 154	Centred single element coupling	Friction bearing	yes	Flange – joint shaft		5, 18
BR 155	Centred single element coupling	Friction bearing	yes	Flange – joint shaft	Short installed length	5, 19
BR 157	Centred single element coupling	Friction bearing	yes	Solid shaft – joint shaft	Smallest coupling inertia at universal joint shaft side	5, 20
BR 158	Centred single element coupling	Friction bearing	yes	Solid shaft – joint shaft	Biggest coupling inertia at universal joint shaft side	5, 21
BR 159	Centred twin element coupling with double torsional elasticity	Friction and antifriction bearing	no	Flange – joint shaft	Particularly suitable for engine test rigs	6, 22
BR 160	Centred twin element coupling	Antifriction bearing	no	Engine flywheel – joint shaft	For higher speeds	8, 23
BR 161	Centred twin element coupling	Antifriction bearing	no	Flange – joint shaft	For higher speeds	8, 24
BR 170	Centred twin element coupling	Antifriction bearing	yes	Engine flywheel – joint shaft	For higher speeds	10, 25
BR 171	Centred twin element coupling	Antifriction bearing	yes	Flange – joint shaft	For higher speeds	10, 26
BR 172	Centred twin element coupling	Friction bearing	yes	Engine flywheel – joint shaft		10, 27
BR 173	Centred twin element coupling	Friction bearing	yes	Flange – joint shaft		10, 28
BR 190	Coupling design with longitudinal expansion compensation shaft	Friction bearing	no	Engine flywheel – flange	Particularly suitable for engine test rigs	12, 29
BR 198*	Coupling design consisting of: – highly flexible coupling – synchronising shaft	Friction and antifriction bearing	yes	Engine flywheel – synchronous shaft		
BR 199*	Coupling design consisting of: – highly flexible coupling – joint shaft – connecting elements, if required					

Product range highly flexible outrigger bearing couplings

Designation	Type of coupling	Bearing type	Frictional damping	Connection	Notes
BR 142*	Centred single element coupling as flange bearing	Antifriction bearing	yes	Engine flywheel/housing – joint shaft	Relatively small mass on the flywheel
BR 144*	Centred single element coupling as flange bearing	Antifriction bearing	yes	Engine flywheel/housing – joint shaft	Relatively big mass on the flywheel

*Coupling parameters and dimensions available on request

Coupling parameters

Single standard elastomer element, preloaded, with frictional damping

Series 150



Series 151



Series 152



Series 153

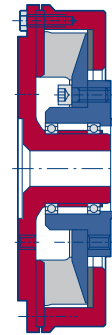

Size	Shore hardness shA [°]	Nominal torque T_{KN} [Nm]	Maximum torque T_{Kmax} [Nm]	Adm. cont. altern. torque T_{KW} [Nm]	Dyn. torsional rigidity C_{Tdyn} [Nm/rad]	Adm. power loss P_{KV} [W]	Relative damping ψ
K 005	N 45	180	540	65	950	90	1.6
	N 50	200	600	70	1 400		
	N 60	220	660	75	2 100		
	N 70	240	720	85	4 100		
K 010	N 45	260	780	90	1 300	110	1.6
	N 50	300	900	105	2 000		
	N 60	330	990	115	3 000		
	N 70	360	1 080	125	6 200		
K 015	N 45	350	1 050	120	1 700	130	1.6
	N 50	390	1 170	135	2 600		
	N 60	430	1 290	150	4 000		
	N 70	480	1 440	170	8 100		
K 020	N 45	450	1 350	160	2 100	150	1.6
	N 50	510	1 530	180	3 600		
	N 60	570	1 710	200	5 000		
	N 70	620	1 860	215	10 600		
K 025	N 45	590	1 770	180	2 800	170	1.6
	N 50	660	1 980	200	4 600		
	N 60	730	2 190	220	6 800		
	N 70	810	2 430	245	13 600		
K 030	N 45	750	2 250	225	3 600	200	1.6
	N 50	840	2 520	250	6 000		
	N 60	930	2 790	280	8 800		
	N 70	1 030	3 090	310	17 950		
K 035	N 45	960	2 880	290	4 600	230	1.6
	N 50	1 090	3 270	325	7 600		
	N 60	1 210	3 630	365	11 700		
	N 70	1 330	3 990	400	22 600		
K 040	N 45	1 240	3 720	370	6 000	260	1.6
	N 50	1 400	4 200	420	9 800		
	N 60	1 550	4 650	465	15 000		
	N 70	1 710	5 130	515	29 100		
K 045	N 45	1 680	5 040	420	8 500	310	1.6
	N 50	1 890	5 670	470	13 300		
	N 60	2 100	6 300	525	20 400		
	N 70	2 310	6 930	580	39 500		
K 050	N 45	2 170	6 510	540	10 500	350	1.6
	N 50	2 440	7 320	610	17 100		
	N 60	2 710	8 130	680	26 000		
	N 70	2 990	8 970	750	50 000		
K 055	N 45	2 990	8 970	750	14 600	420	1.6
	N 50	3 360	10 080	840	23 600		
	N 60	3 730	11 190	935	36 400		
	N 70	4 110	12 330	1 030	70 500		
K 060	N 45	4 400	13 200	1 100	21 400	510	1.6
	N 50	4 950	14 850	1 240	34 700		
	N 60	5 500	16 500	1 375	53 000		
	N 70	6 050	18 150	1 515	103 400		

Dyn. torsional rigidity at 20°C

Adm. temperature at the natural rubber surface between -40 to +90 °C

Series 154

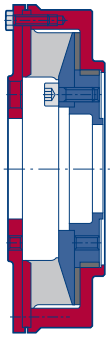

Series 155

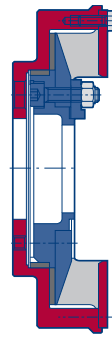

Series 157

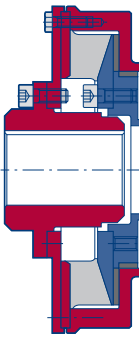

Series 158

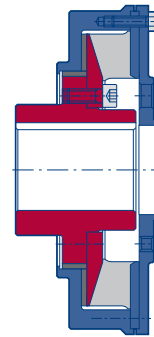

Size	Shore hardness shA [°]	Nominal torque T_{KN} [Nm]	Maximum torque T_{Kmax} [Nm]	Adm. cont. altern. torque T_{KW} [Nm]	Dyn. torsional rigidity C_{Tdyn} [Nm/rad]	Adm. power loss P_{KV} [W]	Relative damping ψ
K 065	N 45	6 300	18 900	1 260	31 000	630	1.6
	N 50	7 100	21 300	1 420	50 000		
	N 60	7 900	23 700	1 580	77 000		
	N 70	8 700	26 100	1 740	149 500		
K 070	N 45	9 100	27 300	1 820	44 300	760	1.6
	N 50	10 200	30 600	2 040	71 500		
	N 60	11 400	34 200	2 280	110 000		
	N 70	12 500	37 500	2 500	213 400		
K 075	N 45	12 400	37 200	2 480	61 000	900	1.6
	N 50	14 000	42 000	2 800	98 000		
	N 60	15 500	46 500	3 100	151 000		
	N 70	17 100	51 300	3 420	290 000		
K 080	N 45	16 900	50 700	3 380	82 300	1 060	1.6
	N 50	19 000	57 000	3 800	133 000		
	N 60	21 100	63 300	4 220	205 000		
	N 70	23 200	69 600	4 640	397 000		
K 085	N 45	23 900	71 700	4 780	117 000	1 280	1.6
	N 50	26 900	80 700	5 380	188 000		
	N 60	29 900	89 700	5 980	290 000		
	N 70	32 900	98 700	6 580	562 000		
K 090	N 45	35 700	98 200	6 660	216 000	1 530	1.6
	N 50	41 200	113 300	7 500	360 000		
	N 60	45 400	124 800	8 320	525 600		
	N 70	49 000	134 700	9 160	1 080 000		
K 095	N 45	48 500	145 500	9 700	245 000	-	1.6
	N 50	54 600	163 000	10 920	400 000		
	N 60	60 600	181 000	12 120	600 000		
	N 70	66 700	200 100	13 340	1 200 000		
K 100	N 45	64 400	193 200	12 880	320 000	-	1.6
	N 50	72 400	217 000	14 480	520 000		
	N 60	80 500	240 000	16 100	790 000		
	N 70	88 500	265 500	17 700	1 550 000		
K 105	N 45	80 000	240 000	16 000	430 000	-	1.6
	N 50	90 000	270 000	18 000	690 000		
	N 60	100 000	300 000	20 000	1 100 000		
	N 70	110 000	330 000	22 000	2 100 000		
K 110	N 45	105 000	315 000	21 000	620 000	-	1.6
	N 50	118 000	354 000	23 600	1 000 000		
	N 60	131 000	390 000	26 200	1 500 000		
	N 70	144 200	432 600	28 840	3 000 000		
K 115	N 45	130 000	390 000	26 000	830 000	-	1.6
	N 50	146 100	438 000	29 220	1 323 000		
	N 60	162 300	487 000	32 460	2 000 000		
	N 70	178 500	535 500	35 700	4 000 000		
K 120	N 45	161 100	483 300	32 220	1 100 000	-	1.6
	N 50	181 000	542 000	36 240	1 764 000		
	N 60	201 300	604 000	40 260	2 700 000		
	N 70	221 500	664 500	44 300	5 300 000		

Dyn. torsional rigidity at 20°C

Adm. temperature at the natural rubber surface between -40 to +90 °C

Coupling parameters

Twin standard elastomer elements in series, preloaded, without friction damping

Series 159

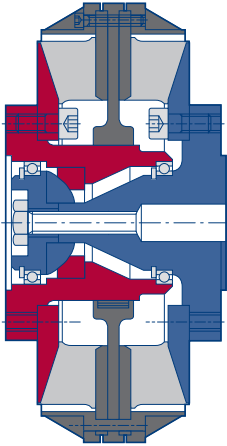

Size	Shore hardness shA [°]	Nominal torque T_{KN} [Nm]	Maximum torque T_{Kmax} [Nm]	Adm. cont. altern. torque T_{KW} [Nm]	Dyn. torsional rigidity C_{Tdyn} [Nm/rad]	Adm. power loss P_{KV} [W]	Relative damping ψ
K 005	N 45	180	540	65	475	100	0.75
	N 50	200	600	70	700		0.75
	N 60	220	660	75	1050		0.95
	N 70	240	720	85	2050		1.15
K 010	N 45	260	780	90	650	130	0.75
	N 50	300	900	105	1000		0.75
	N 60	330	990	115	1500		0.95
	N 70	360	1080	125	3100		1.15
K 015	N 45	350	1050	120	850	150	0.75
	N 50	390	1170	135	1300		0.75
	N 60	430	1290	150	2000		0.95
	N 70	480	1440	170	4050		1.15
K 020	N 45	450	1350	160	1050	170	0.75
	N 50	510	1530	180	1800		0.75
	N 60	570	1710	200	2500		0.95
	N 70	620	1860	215	5300		1.15
K 025	N 45	590	1770	180	1400	200	0.75
	N 50	660	1980	200	2300		0.75
	N 60	730	2190	220	3400		0.95
	N 70	810	2430	245	6800		1.15
K 030	N 45	750	2250	225	1800	220	0.75
	N 50	840	2520	250	3000		0.75
	N 60	930	2790	280	4400		0.95
	N 70	1030	3090	310	9000		1.15
K 035	N 45	960	2880	290	2300	250	0.75
	N 50	1090	3270	325	3800		0.75
	N 60	1210	3630	365	5850		0.95
	N 70	1330	3990	400	11300		1.15

Dyn. torsional rigidity at 20°C

Adm. temperature at the natural rubber surface between -40 to +90 °C

Sizes bigger K 060 available on request

Size	Shore hardness shA [°]	Nominal torque T_{KN} [Nm]	Maximum torque T_{Kmax} [Nm]	Adm. cont. altern. torque T_{KW} [Nm]	Dyn. torsional rigidity C_{Tdyn} [Nm/rad]	Adm. power loss P_{KV} [W]	Relative damping ψ
K 040	N 45	1240	3720	370	3000	290	0.75
	N 50	1400	4200	420	4900		0.75
	N 60	1550	4650	465	7500		0.95
	N 70	1710	5130	515	14550		1.15
K 045	N 45	1680	5040	420	4250	340	0.75
	N 50	1890	5670	470	6650		0.75
	N 60	2100	6300	525	10200		0.95
	N 70	2310	6930	580	19750		1.15
K 050	N 45	2170	6510	540	5250	390	0.75
	N 50	2440	7320	610	8550		0.75
	N 60	2710	8130	680	13000		0.95
	N 70	2990	8970	750	25000		1.15
K 055	N 45	2990	8970	750	7300	460	0.75
	N 50	3360	10080	840	11800		0.75
	N 60	3730	11190	935	18200		0.95
	N 70	4110	12330	1030	35250		1.15
K 060	N 45	4400	13200	1100	10700	570	0.75
	N 50	4950	14850	1240	17350		0.75
	N 60	5500	16500	1375	26500		0.95
	N 70	6050	18150	1515	51700		1.15

Dyn. torsional rigidity at 20°C

Adm. temperature at the natural rubber surface between -40 to +90 °C

Sizes bigger K 060 available on request

Coupling parameters

Twin standard elastomer elements in parallel, preloaded, without friction damping

Series 160

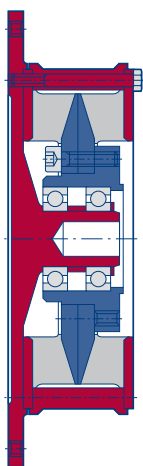

Series 161

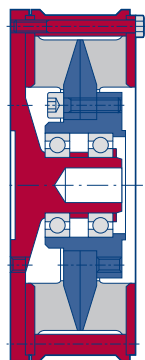

Size	Shore hardness shA [°]	Nominal torque T_{KN} [Nm]	Maximum torque T_{Kmax} [Nm]	Adm. cont. altern. torque T_{KW} [Nm]	Dyn. torsional rigidity C_{Tdyn} [Nm/rad]	Adm. power loss P_{KV} [W]	Relative damping ψ
K 005	N 45	360	1 080	130	1 900	100	0.75
	N 50	400	1 200	140	2 800		0.75
	N 60	440	1 320	150	4 200		0.95
	N 70	480	1 440	170	8 200		1.15
K 010	N 45	520	1 560	180	2 600	130	0.75
	N 50	600	1 800	210	4 000		0.75
	N 60	660	1 980	230	6 000		0.95
	N 70	720	2 160	250	12 400		1.15
K 015	N 45	700	2 100	240	3 400	150	0.75
	N 50	780	2 340	270	5 200		0.75
	N 60	860	2 580	300	8 000		0.95
	N 70	960	2 880	340	16 200		1.15
K 020	N 45	900	2 700	320	4 200	170	0.75
	N 50	1 020	3 060	360	7 200		0.75
	N 60	1 140	3 420	400	10 000		0.95
	N 70	1 240	3 720	430	21 200		1.15
K 025	N 45	1 180	3 540	360	5 600	200	0.75
	N 50	1 320	3 960	400	9 200		0.75
	N 60	1 460	4 380	440	13 600		0.95
	N 70	1 620	4 860	490	27 200		1.15
K 030	N 45	1 500	4 500	450	7 200	220	0.75
	N 50	1 680	5 040	500	12 000		0.75
	N 60	1 860	5 580	560	17 600		0.95
	N 70	2 060	6 180	620	35 900		1.15
K 035	N 45	1 920	5 760	580	9 200	250	0.75
	N 50	2 180	6 540	650	15 200		0.75
	N 60	2 420	7 260	730	23 400		0.95
	N 70	2 660	7 980	800	45 200		1.15
K 040	N 45	2 480	7 440	740	12 000	290	0.75
	N 50	2 800	8 400	840	19 600		0.75
	N 60	3 100	9 300	930	30 000		0.95
	N 70	3 420	10 260	1 030	58 200		1.15
K 045	N 45	3 360	10 080	840	17 000	340	0.75
	N 50	3 780	11 340	940	26 600		0.75
	N 60	4 200	12 600	1 050	40 800		0.95
	N 70	4 620	13 860	1 160	79 000		1.15
K 050	N 45	4 340	13 020	1 080	21 000	390	0.75
	N 50	4 880	14 640	1 220	34 200		0.75
	N 60	5 420	16 260	1 360	52 000		0.95
	N 70	5 980	17 940	1 500	100 000		1.15

Dyn. torsional rigidity at 20°C

Adm. temperature at the natural rubber surface between -40 to +90 °C

Size	Shore hardness shA [°]	Nominal torque T_{KN} [Nm]	Maximum torque T_{Kmax} [Nm]	Adm. cont. altern. torque T_{KW} [Nm]	Dyn. torsional rigidity C_{Tdyn} [Nm/rad]	Adm. power loss P_{KV} [W]	Relative damping ψ
K 055	N 45	5 980	17 940	1 500	29 200	460	0.75
	N 50	6 720	20 160	1 680	47 200		0.75
	N 60	7 460	22 380	1 870	72 800		0.95
	N 70	8 220	24 660	2 060	141 000		1.15
K 060	N 45	8 800	26 400	2 200	42 800	570	0.75
	N 50	9 900	29 700	2 480	69 400		0.75
	N 60	11 000	33 000	2 750	106 000		0.95
	N 70	12 100	36 300	3 030	206 800		1.15
K 065	N 45	12 600	37 800	2 520	62 000	690	0.75
	N 50	14 200	42 600	2 840	100 000		0.75
	N 60	15 800	47 400	3 160	154 000		0.95
	N 70	17 400	52 200	3 480	299 000		1.15
K 070	N 45	18 200	54 600	3 640	88 600	840	0.75
	N 50	20 400	61 200	4 080	143 000		0.75
	N 60	22 800	68 400	4 560	220 000		0.95
	N 70	25 000	75 000	5 000	426 800		1.15
K 075	N 45	24 800	74 400	4 960	122 000	980	0.75
	N 50	28 000	84 000	5 600	196 000		0.75
	N 60	31 000	93 000	6 200	302 000		0.95
	N 70	34 200	102 600	6 840	580 000		1.15
K 080	N 45	33 800	101 400	6 760	164 600	1 160	0.75
	N 50	38 000	114 000	7 600	266 000		0.75
	N 60	42 200	126 600	8 440	410 000		0.95
	N 70	46 400	139 200	9 280	794 000		1.15
K 085	N 45	47 800	143 400	9 560	234 000	1 390	0.75
	N 50	53 800	161 400	10 760	376 000		0.75
	N 60	59 800	179 400	11 960	580 000		0.95
	N 70	65 800	197 400	13 160	1 124 000		1.15
K 090	N 45	71 400	196 400	13 320	432 000	1 660	0.75
	N 50	82 400	226 600	15 000	720 000		0.75
	N 60	90 800	249 600	16 640	1 051 200		0.95
	N 70	98 000	269 400	18 320	2 160 000		1.15
K 095	N 45	97 000	291 000	19 400	490 000	-	0.75
	N 50	109 200	326 000	21 840	800 000		0.75
	N 60	121 200	362 000	24 240	1 200 000		0.95
	N 70	133 400	400 200	26 680	2 400 000		1.15
K 100	N 45	128 800	386 400	25 760	640 000	-	0.75
	N 50	144 800	434 000	28 960	1 040 000		0.75
	N 60	161 000	480 000	32 200	1 580 000		0.95
	N 70	177 000	531 000	35 400	3 100 000		1.15
K 105	N 45	160 000	480 000	32 000	860 000	-	0.75
	N 50	180 000	540 000	36 000	1 380 000		0.75
	N 60	200 000	600 000	40 000	2 200 000		0.95
	N 70	220 000	660 000	44 000	4 200 000		1.15
K 110	N 45	210 000	630 000	42 000	1 240 000	-	0.75
	N 50	236 000	708 000	47 200	2 000 000		0.75
	N 60	262 000	780 000	52 400	3 000 000		0.95
	N 70	288 400	865 200	57 680	6 000 000		1.15
K 115	N 45	260 000	780 000	52 000	1 660 000	-	0.75
	N 50	292 200	876 000	58 440	2 646 000		0.75
	N 60	324 600	974 000	64 920	4 000 000		0.95
	N 70	357 000	1 071 000	71 400	8 000 000		1.15
K 120	N 45	322 200	966 600	64 440	2 200 000	-	0.75
	N 50	362 000	1 084 000	72 480	3 528 000		0.75
	N 60	402 600	1 208 000	80 520	5 400 000		0.95
	N 70	443 000	1 329 000	88 600	10 600 000		1.15

Dyn. torsional rigidity at 20°C

Adm. temperature at the natural rubber surface between -40 to +90 °C

Coupling parameters

Twin standard elastomer elements in parallel, preloaded, with friction damping

Series 170

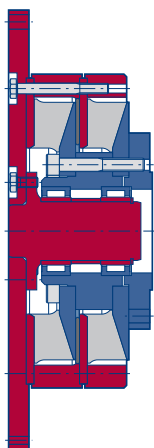

Series 171

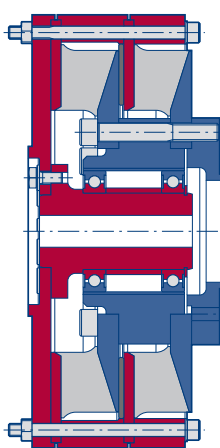

Series 172

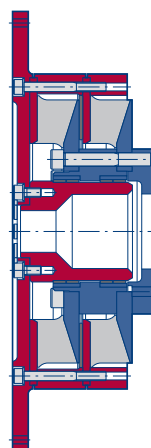

Series 173

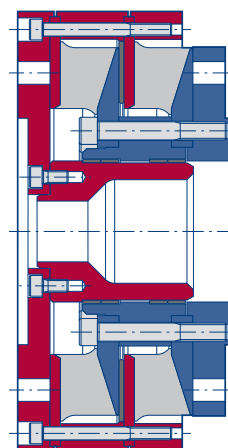

Size	Shore hardness shA [°]	Nominal torque T_{KN} [Nm]	Maximum torque T_{Kmax} [Nm]	Adm. cont. altern. torque T_{KW} [Nm]	Dyn. torsional rigidity C_{Tdyn} [Nm/rad]	Adm. power loss P_{KV} [W]	Relative damping ψ
K 005	N 45	360	1 080	130	1 900	140	1.6
	N 50	400	1 200	140	2 800		
	N 60	440	1 320	150	4 200		
	N 70	480	1 440	170	8 200		
K 010	N 45	520	1 560	180	2 600	175	1.6
	N 50	600	1 800	210	4 000		
	N 60	660	1 980	230	6 000		
	N 70	720	2 160	250	12 400		
K 015	N 45	700	2 100	240	3 400	205	1.6
	N 50	780	2 340	270	5 200		
	N 60	860	2 580	300	8 000		
	N 70	960	2 880	340	16 200		
K 020	N 45	900	2 700	320	4 200	235	1.6
	N 50	1 020	3 060	360	7 200		
	N 60	1 140	3 420	400	10 000		
	N 70	1 240	3 720	430	21 200		
K 025	N 45	1 180	3 540	360	5 600	270	1.6
	N 50	1 320	3 960	400	9 200		
	N 60	1 460	4 380	440	13 600		
	N 70	1 620	4 860	490	27 200		
K 030	N 45	1 500	4 500	450	7 200	310	1.6
	N 50	1 680	5 040	500	12 000		
	N 60	1 860	5 580	560	17 600		
	N 70	2 060	6 180	620	35 900		
K 035	N 45	1 920	5 760	580	9 200	355	1.6
	N 50	2 180	6 540	650	15 200		
	N 60	2 420	7 260	730	23 400		
	N 70	2 660	7 980	800	45 200		
K 040	N 45	2 480	7 440	740	12 000	405	1.6
	N 50	2 800	8 400	840	19 600		
	N 60	3 100	9 300	930	30 000		
	N 70	3 420	10 260	1 030	58 200		
K 045	N 45	3 360	10 080	840	17 000	480	1.6
	N 50	3 780	11 340	940	26 600		
	N 60	4 200	12 600	1 050	40 800		
	N 70	4 620	13 860	1 160	79 000		
K 050	N 45	4 340	13 020	1 080	21 000	545	1.6
	N 50	4 880	14 640	1 220	34 200		
	N 60	5 420	16 260	1 360	52 000		
	N 70	5 980	17 940	1 500	100 000		

Dyn. torsional rigidity at 20°C

Adm. temperature at the natural rubber surface between -40 to +90 °C

Size	Shore hardness shA [°]	Nominal torque T_{KN} [Nm]	Maximum torque T_{Kmax} [Nm]	Adm. cont. altern. torque T_{KW} [Nm]	Dyn. torsional rigidity C_{Tdyn} [Nm/rad]	Adm. power loss P_{KV} [W]	Relative damping ψ
K 055	N 45	5 980	17 940	1 500	29 200	650	1.6
	N 50	6 720	20 160	1 680	47 200		
	N 60	7 460	22 380	1 870	72 800		
	N 70	8 220	24 660	2 060	141 000		
K 060	N 45	8 800	26 400	2 200	42 800	795	1.6
	N 50	9 900	29 700	2 480	69 400		
	N 60	11 000	33 000	2 750	106 000		
	N 70	12 100	36 300	3 030	206 800		
K 065	N 45	12 600	37 800	2 520	62 000	975	1.6
	N 50	14 200	42 600	2 840	100 000		
	N 60	15 800	47 400	3 160	154 000		
	N 70	17 400	52 200	3 480	299 000		
K 070	N 45	18 200	54 600	3 640	88 600	1 180	1.6
	N 50	20 400	61 200	4 080	143 000		
	N 60	22 800	68 400	4 560	220 000		
	N 70	25 000	75 000	5 000	426 800		
K 075	N 45	24 800	74 400	4 960	122 000	1 390	1.6
	N 50	28 000	84 000	5 600	196 000		
	N 60	31 000	93 000	6 200	302 000		
	N 70	34 200	102 600	6 840	580 000		
K 080	N 45	33 800	101 400	6 760	164 600	1 640	1.6
	N 50	38 000	114 000	7 600	266 000		
	N 60	42 200	126 600	8 440	410 000		
	N 70	46 400	139 200	9 280	794 000		
K 085	N 45	47 800	143 400	9 560	234 000	1 975	1.6
	N 50	53 800	161 400	10 760	376 000		
	N 60	59 800	179 400	11 960	580 000		
	N 70	65 800	197 400	13 160	1 124 000		
K 090	N 45	71 400	196 400	13 320	432 000	2 360	1.6
	N 50	82 400	226 600	15 000	720 000		
	N 60	90 800	249 600	16 640	1 051 200		
	N 70	98 000	269 400	18 320	2 160 000		
K 095	N 45	97 000	291 000	19 400	490 000	-	1.6
	N 50	109 200	326 000	21 840	800 000		
	N 60	121 200	362 000	24 240	1 200 000		
	N 70	133 400	400 200	26 680	2 400 000		
K 100	N 45	128 800	386 400	25 760	640 000	-	1.6
	N 50	144 800	434 000	28 960	1 040 000		
	N 60	161 000	480 000	32 200	1 580 000		
	N 70	177 000	531 000	35 400	3 100 000		
K 105	N 45	160 000	480 000	32 000	860 000	-	1.6
	N 50	180 000	540 000	36 000	1 380 000		
	N 60	200 000	600 000	40 000	2 200 000		
	N 70	220 000	660 000	44 000	4 200 000		
K 110	N 45	210 000	630 000	42 000	1 240 000	-	1.6
	N 50	236 000	708 000	47 200	2 000 000		
	N 60	262 000	780 000	52 400	3 000 000		
	N 70	288 400	865 200	57 680	6 000 000		
K 115	N 45	260 000	780 000	52 000	1 660 000	-	1.6
	N 50	292 200	876 000	58 440	2 646 000		
	N 60	324 600	974 000	64 920	4 000 000		
	N 70	357 000	1 071 000	71 400	8 000 000		
K 120	N 45	322 200	966 600	64 440	2 200 000	-	1.6
	N 50	362 000	1 084 000	72 480	3 528 000		
	N 60	402 600	1 208 000	80 520	5 400 000		
	N 70	443 000	1 329 000	88 600	10 600 000		

Dyn. torsional rigidity at 20°C

Adm. temperature at the natural rubber surface between -40 to +90 °C

Coupling parameters

Two couplings in series with two parallel standard elastomer elements each, preloaded without friction damping

Series 190

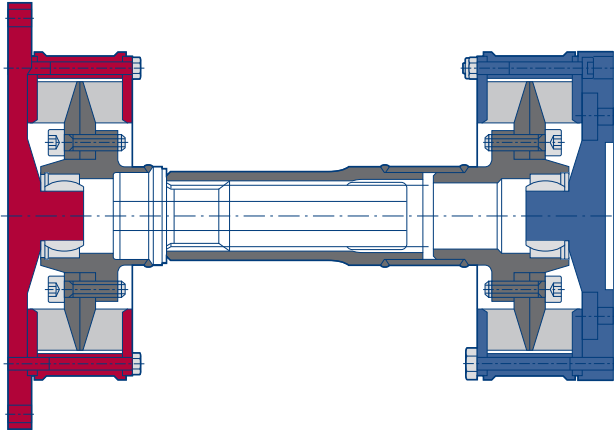

Size	Shore hardness shA [°]	Nominal torque T_{KN} [Nm]	Maximum torque T_{Kmax} [Nm]	Adm. cont. altern. torque T_{KW} [Nm]	Dyn. torsional rigidity C_{Tdyn} [Nm/rad]	Adm. power loss P_{KV} [W]	Relative damping ψ
K 005	N 45	360	1 080	130	950	200	0.75
	N 50	400	1 200	140	1 400		0.75
	N 60	440	1 320	150	2 100		0.95
	N 70	480	1 440	170	4 100		1.15
K 010	N 45	520	1 560	180	1 300	260	0.75
	N 50	600	1 800	210	2 000		0.75
	N 60	660	1 980	230	3 000		0.95
	N 70	720	2 160	250	6 200		1.15
K 015	N 45	700	2 100	240	1 700	300	0.75
	N 50	780	2 340	270	2 600		0.75
	N 60	860	2 580	300	4 000		0.95
	N 70	960	2 880	340	8 100		1.15
K 020	N 45	900	2 700	320	2 100	340	0.75
	N 50	1 020	3 060	360	3 600		0.75
	N 60	1 140	3 420	400	5 000		0.95
	N 70	1 240	3 720	430	10 600		1.15
K 025	N 45	1 180	3 540	360	2 800	400	0.75
	N 50	1 320	3 960	400	4 600		0.75
	N 60	1 460	4 380	440	6 800		0.95
	N 70	1 620	4 860	490	13 600		1.15
K 030	N 45	1 500	4 500	450	3 600	440	0.75
	N 50	1 680	5 040	500	6 000		0.75
	N 60	1 860	5 580	560	8 800		0.95
	N 70	2 060	6 180	620	17 950		1.15
K 035	N 45	1 920	5 760	580	4 600	500	0.75
	N 50	2 180	6 540	650	7 600		0.75
	N 60	2 420	7 260	730	11 700		0.95
	N 70	2 660	7 980	800	22 600		1.15

Dyn. torsional rigidity at 20°C

Adm. temperature at the natural rubber surface between -40 to +90 °C

Size	Shore hardness shA [°]	Nominal torque T_{KN} [Nm]	Maximum torque T_{Kmax} [Nm]	Adm. cont. altern. torque T_{KW} [Nm]	Dyn. torsional rigidity C_{Tdyn} [Nm/rad]	Adm. power loss P_{KV} [W]	Relative damping ψ
K 040	N 45	2480	7440	740	6000	580	0.75
	N 50	2800	8400	840	9800		0.75
	N 60	3100	9300	930	15000		0.95
	N 70	3420	10260	1030	29100		1.15
K 045	N 45	3360	10080	840	8500	680	0.75
	N 50	3780	11340	940	13300		0.75
	N 60	4200	12600	1050	20400		0.95
	N 70	4620	13860	1160	39500		1.15
K 050	N 45	4340	13020	1080	10500	780	0.75
	N 50	4880	14640	1220	17100		0.75
	N 60	5420	16260	1360	26000		0.95
	N 70	5980	17940	1500	50000		1.15
K 055	N 45	5980	17940	1500	14600	920	0.75
	N 50	6720	20160	1680	23600		0.75
	N 60	7460	22380	1870	36400		0.95
	N 70	8220	24660	2060	70500		1.15
K 060	N 45	8800	26400	2200	21400	1140	0.75
	N 50	9900	29700	2480	34700		0.75
	N 60	11000	33000	2750	53000		0.95
	N 70	12100	36300	3030	103400		1.15
K 065	N 45	12600	37800	2520	31000	1380	0.75
	N 50	14200	42600	2840	50000		0.75
	N 60	15800	47400	3160	77000		0.95
	N 70	17400	52200	3480	149500		1.15
K 070	N 45	18200	54600	3640	44300	1680	0.75
	N 50	20400	61200	4080	71500		0.75
	N 60	22800	68400	4560	110000		0.95
	N 70	25000	75000	5000	213400		1.15

Dyn. torsional rigidity at 20°C

Adm. temperature at the natural rubber surface between -40 to +90 °C

Sizes bigger K 070 available on request

Dimensions

Series 150

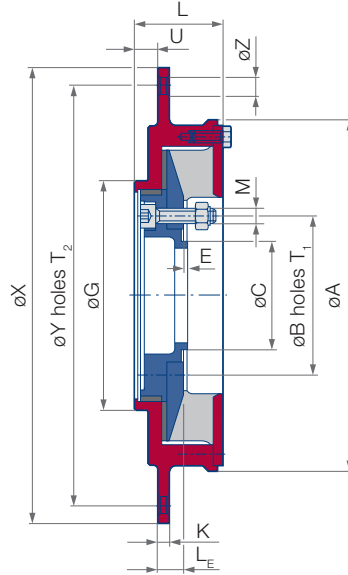

Size	Flywheel	Flywheel connecting dimensions								Joint shaft connecting dimensions								Mass m [kg]	Mass moments of inertia	
		SAE J620	X _{g7}	Y _{±0,2}	Z	T ₂	K	G	U	Flange diameter	C _{g7}	B _{±0,2}	M	T ₁	E	A	L		L _E	J _A [kgm ²]
K 005	6.5	215.9	200.0	9	6	8	110	10	90	47	74.5	8	4	2	166	42.2	13.0	4.3	0.020	0.002
	7.5	241.3	222.3	9	8	8	8	10	90	47	74.5	8	4	2	166	42.2	13.0	4.8	0.027	0.002
K 010	7.5	241.3	222.3	9	8	8	8	10	100	57	84	8	6	2	186	46.7	16.0	5.5	0.031	0.004
	8	263.5	244.5	11	6	8	8	10	100	57	84	8	6	2	186	46.7	16.0	6.0	0.040	0.004
K 015	7.5	241.3	222.3	9	8	8	122	10	100	57	84	8	6	2	198	49.8	17.8	6.4	0.039	0.006
	8	263.5	244.5	11	6	10	122	10	100	57	84	8	6	2	198	49.8	17.8	7.3	0.052	0.006
K 020	8	263.5	244.5	11	6	10	144	10	120	75	101.5	10	8	2	226	54.4	19.0	8.8	0.072	0.008
	10	314.3	295.3	11	8	10	144	13	120	75	101.5	10	8	2	226	54.4	16.0	10.5	0.107	0.008
K 025	10	314.3	295.3	11	8	10	144	13	120	75	101.5	10	8	2	240	56.7	18.4	11.4	0.113	0.012
	11.5	352.4	333.4	11	8	10	144	26	120	75	101.5	10	8	2	240	56.7	5.4	12.9	0.154	0.012
K 030	10	314.3	295.3	11	8	11	13	13	150	90	130	12	8	2	266	65.7	22.4	14.2	0.144	0.024
	11.5	352.4	333.4	11	8	11	180	26	150	90	130	12	8	2	266	65.7	9.4	15.7	0.184	0.024
K 035	14	466.7	438.2	14	8	12	26	26	150	90	130	12	8	2	284	68.0	9.4	22.7	0.474	0.024
	11.5	352.4	333.4	11	8	12	180	26	150	90	130	12	8	2	284	68.0	10.8	16.5	0.210	0.030
K 040	14	466.7	438.2	14	8	12	210	26	180	110	155.5	14	8	2	316	76.7	10.8	23.4	0.497	0.030
	11.5	352.4	333.4	11	8	14	26	26	180	110	155.5	14	8	2	316	76.7	15.3	20.6	0.278	0.052
K 045	14	466.7	438.2	14	8	12	216	25	180	110	155.5	14	8	2	340	84.2	15.3	27.4	0.563	0.052
	14	466.7	438.2	14	8	12	216	25	180	110	155.5	14	8	2	340	84.2	22.6	32.3	0.649	0.085
K 050	14	466.7	438.2	14	8	12	258	25	225	140	196	16	8	4	380	92.5	22.6	37.6	0.649	0.085
	14	466.7	438.2	14	8	12	258	25	225	140	196	16	8	4	380	92.5	23.6	37.6	0.816	0.137
K 055	16	517.5	489.0	14	8	12	286	25	250	140	218	18	8	4	424	104.1	23.6	50.9	0.816	0.137
	16	517.5	489.0	14	8	12	286	25	250	140	218	18	8	4	424	104.1	29.0	50.9	1.35	0.233
K 060	18	571.5	542.9	18	6	16	322	29	285	175	245	20	8	5	476	116.2	31.4	73.0	1.35	0.233
	18	571.5	542.9	18	6	16	322	29	285	175	245	20	8	5	476	116.2	31.4	73.0	2.44	0.429
K 065	21	673.1	641.4	18	12	16	363	29	315	175	280	22	8	5	534	129.5	38.0	104.0	4.55	0.774
	21	673.1	641.4	18	12	16	400	29	315	175	280	22	8	5	534	129.5	38.0	104.0	4.55	0.774
K 070	24	733.4	692.2	20	12	18	444	24	350	220	310	22	10	6	594	144.7	46.6	132.0	6.35	1.33
	21	673.1	641.4	18	12	16	400	29	350	220	310	22	10	6	594	144.7	46.6	140.0	7.33	1.33
K 075	24	733.4	692.2	20	12	18	444	24	390	250	345	24	10	6	656	159.5	58.2	173.0	10.04	2.26
	24	733.4	692.2	20	12	18	444	24	390	250	345	24	10	6	656	159.5	58.2	173.0	10.04	2.26
K 080	-	786.0	750.0	24	12	22	491	60	435	280	385	27	10	8	726	175.2	28.8	260.0	18.71	3.70
	-	786.0	750.0	24	12	22	491	60	435	280	385	27	10	8	726	175.2	28.8	260.0	18.71	3.70

Dimensions in mm

Mass and mass moment of inertia are based on the use of steel

Aluminum is available on request

Sizes bigger K 080 are available on request

Dimensions

Series 151

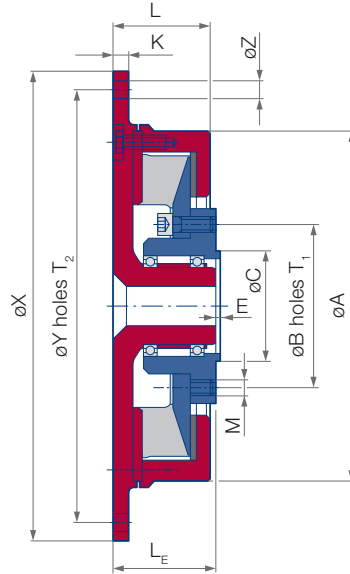

Size	Flywheel	Flywheel connecting dimensions						Joint shaft connecting dimensions							Mass m [kg]	Mass moments of inertia		
		SAE J620	X _{g7}	Y _{±0,2}	Z	T ₂	K	Flange diameter	C _{g7}	B _{±0,1}	M	T ₁	E	A		L	L _E	Primary side J _A [kgm ²]
K 005	6.5	215.9	200.0	9	6	8	90	47	74.5	8	4	2	162	45.2	50	6.7	0.024	0.002
	7.5	241.3	222.3	9	8	8	90	47	74.5	8	4	2	162	45.2	50	7.3	0.031	0.002
K 010	7.5	241.3	222.3	9	8	8	90	47	74.5	8	4	2	180	47.7	50	8.0	0.038	0.004
	8	263.5	244.5	11	6	8	100	57	84	8	6	2	180	47.7	50	8.9	0.052	0.004
K 015	7.5	241.3	222.3	9	8	8	90	47	74.5	8	4	2	192	50.8	52	8.9	0.047	0.006
	8	263.5	244.5	11	6	10	100	57	84	8	6	2	192	50.8	52	9.8	0.059	0.006
K 020	8	263.5	244.5	11	6	10	100	57	84	8	6	2	220	56.4	63	13.1	0.083	0.008
	10	314.3	295.3	11	8	10	120	75	101.5	10	8	2	220	56.4	63	14.8	0.119	0.008
K 025	10	314.3	295.3	11	8	10	100	57	84	8	6	2	234	58.7	63	16.6	0.141	0.012
	11.5	352.4	333.4	11	8	10	120	75	101.5	10	8	2	234	58.7	63	18.1	0.183	0.012
K 030	10	314.3	295.3	11	8	11	120	75	101.5	10	8	2	260	67.7	70	20.7	0.190	0.025
	11.5	352.4	333.4	11	8	11	120	75	101.5	10	8	2	260	67.7	70	22.5	0.240	0.025
K 035	14	466.7	438.2	14	8	12	150	90	130	12	8	2	278	70.0	76	29.1	0.523	0.024
	11.5	352.4	333.4	11	8	12	120	75	101.5	10	8	2	278	70.0	76	24.9	0.277	0.032
K 040	14	466.7	438.2	14	8	12	150	90	130	12	8	2	308	77.7	82	31.5	0.558	0.031
	11.5	352.4	333.4	11	8	14	150	90	130	12	8	2	308	77.7	82	24.9	0.277	0.032
K 045	14	466.7	438.2	14	8	12	180	110	155.5	14	8	2	332	82.2	88	39.3	0.700	0.055
	14	466.7	438.2	14	8	12	150	90	130	12	8	2	332	82.2	88	43.9	0.805	0.083
K 050	14	466.7	438.2	14	8	14	180	110	155.5	14	8	2	372	93.5	97	43.9	0.805	0.082
	16	517.5	489.0	14	8	14	225	140	196	16	8	4	372	93.5	97	56.7	1.06	0.143
K 055	14	466.7	438.2	14	8	21	225	140	196	16	8	4	416	104.1	110	61.1	1.32	0.142
	16	517.5	489.0	14	8	14	250	140	218	18	8	4	416	104.1	110	74.5	1.60	0.242
K 060	16	517.5	489.0	18	6	23	250	140	218	18	8	4	466	117.2	123	78.9	1.86	0.240
	18	571.5	542.9	18	6	18	285	175	245	20	8	5	466	117.2	123	104.8	2.76	0.454
K 065	21	673.1	641.4	18	12	16	285	175	245	20	8	5	524	130.5	137	110.5	3.15	0.453
	24	733.4	692.2	18	12	18	315	175	280	22	8	5	524	130.5	137	145	5.75	0.768
K 070	21	673.1	641.4	18	12	18	315	175	280	22	8	5	584	142.7	145	155	6.90	0.768
	24	733.4	692.2	20	12	18	350	220	310	22	10	6	584	142.7	145	186	7.59	0.993
K 075	21	673.1	641.4	20	12	20	350	220	310	22	10	6	644	159.5	160	193	8.70	0.968
	24	733.4	692.2	20	12	20	390	250	345	24	10	6	644	159.5	160	245	13.03	2.41
K 080	-	798.0	762.0	24	12	24	390	250	345	24	10	6	714	176.2	177	244	13.03	2.38
	-	798.0	762.0	24	12	24	435	280	385	27	10	8	714	176.2	177	334	21.46	3.80
																332	21.46	3.74

Dimensions in mm

Mass and mass moment of inertia are based on the use of steel

Aluminum is available on request

Sizes bigger K 080 are available on request

Dimensions

Series 152

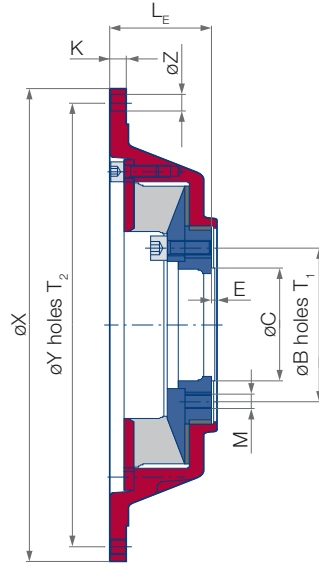

Size	Flywheel SAE J620	Flywheel connecting dimensions						Joint shaft connecting dimensions						Mass m [kg]	Mass moments of inertia	
		X _{g7}	Y _{±0,2}	Z	T ₂	K	Flange diameter	C _{g7}	B _{±0,1}	M	T ₁	E	L _E		J _A [kgm ²]	J _I [kgm ²]
K 005	6.5	215.9	200.0	9	6	8	90	47	74.5	8	4	2	49.2	4.9	0.023	0.002
	7.5	241.3	222.3	9	8	8								5.5	0.030	0.002
K 010	7.5	241.3	222.3	9	8	8	90	47	74.5	8	4	2	53.7	6.5	0.036	0.005
	8	263.5	244.5	11	6	8	100	57	84	8	6	2	53.7	7.0	0.045	0.005
K 015	7.5	241.3	222.3	9	8	8	90	47	74.5	8	4	2	52.8	6.6	0.040	0.006
	8	263.5	244.5	11	6	10	100	57	84	8	6	2	52.8	7.1	0.048	0.006
K 020	8	263.5	244.5	11	6	10	100	57	84	8	6	2	65	8.9	0.068	0.009
	10	314.3	295.3	11	8	10	120	75	101.5	10	8	2	60	10.0	0.095	0.009
K 025	10	314.3	295.3	11	8	10	100	57	84	8	6	2	61.2	12.5	0.122	0.014
	11.5	352.4	333.4	11	8	10	120	75	101.5	10	8	2	61.2	14.0	0.165	0.014
K 030	10	314.3	295.3	11	8	11	120	75	101.5	10	8	2	70	13.6	0.131	0.026
	11.5	352.4	333.4	11	8	11	120	75	101.5	10	8	2	70	15.3	0.177	0.026
K 035	14	466.7	438.2	14	8	12	150	90	130	12	8	2	70	22.5	0.466	0.025
	11.5	352.4	333.4	11	8	12	120	75	101.5	10	8	2	74	21.0	0.246	0.034
K 040	14	466.7	438.2	14	8	12	150	90	130	12	8	2	74	27.0	0.521	0.033
	11.5	352.4	333.4	11	8	14	150	90	130	12	8	2	81	21.0	0.262	0.058
K 045	14	466.7	438.2	14	8	12	180	110	155.5	14	8	2	81	26.2	0.530	0.054
	14	466.7	438.2	14	8	12	150	90	130	12	8	2	89	31.7	0.590	0.090
K 050	14	466.7	438.2	14	8	12	180	110	155.5	14	8	2	89	30.9	0.590	0.086
	14	466.7	438.2	14	8	12	180	110	155.5	14	8	2	105.5	39.7	0.800	0.148
K 055	14	466.7	438.2	14	8	12	225	140	196	16	8	4	105.5	38.2	0.800	0.140
	14	466.7	438.2	14	8	30	180	110	155.5	14	8	2	115.8	56.6	1.41	0.256
K 060	16	517.5	489.0	14	8	42	225	140	196	16	8	4	115.8	54.6	1.41	0.246
	18	571.5	542.9	18	6	42	250	140	218	18	8	4	123.2	73.3	2.24	0.454
K 065	18	571.5	542.9	18	6	45	225	140	196	16	8	4	123.2	85.3	3.16	0.454
	21	673.1	641.4	18	12	22	225	140	196	16	8	4	136.5	101	3.56	0.846
K 070	21	673.1	641.4	18	12	22	250	140	218	18	8	4	136.5	121	5.38	0.846
	24	733.4	692.2	20	12	40	285	175	245	20	8	5	158	154	7.82	1.42
K 075	24	733.4	692.2	20	12	39	315	175	280	22	8	5	158	154	7.82	1.42
	24	733.4	692.2	20	12	39	285	175	245	20	8	5	169	211	12.48	2.55
K 080	24	733.4	692.2	20	12	39	315	175	280	22	8	5	169	211	12.48	2.55
	-	798.0	762.0	24	12	24	435	280	385	27	10	8	200	276	20.23	3.80

Dimensions in mm

Mass and mass moment of inertia are based on the use of steel

Aluminum is available on request

Sizes bigger K 080 are available on request

Dimensions

Series 153

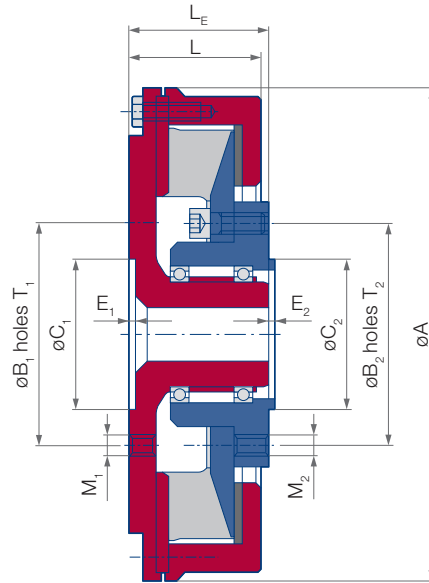

Size	Flange connecting dimensions					Joint shaft connecting dimensions							Mass	Mass moments of inertia				
	Flange diameter	C _{1,H7}	B _{1±0,1}	M ₁	T ₁	E ₁	Flange diameter	C _{2,g7}	B _{2,±0,1}	M ₂	T ₂	E ₂		A	L	L _E	m [kg]	J _A [kgm ²]
K 005	90	47	74.5	8	4	2.5	90	47	74.5	8	4	2	166	45.2	50	5.8 5.8	0.015	0.002
K 010	100	57	84	8	6	2.5	90 100	47 57	74.5 84	8 8	4 6	2 2	186	47.7	50	6.9 6.9	0.025	0.004 0.004
K 015	100	57	84	8	6	2.5	90 100	47 57	74.5 84	8 8	4 6	2 2	198	50.8	52	8.0 8.0	0.036	0.006 0.006
K 020	120	75	101.5	10	8	2.5	100 120	57 75	84 101.5	8 10	6 8	2 2	226	56.4	63	12.0 12.0	0.066	0.008 0.008
K 025	120	75	101.5	10	8	2.5	100 120	57 75	84 101.5	8 10	6 8	2 2	240	58.7	63	14.0 14.0	0.092	0.012 0.012
K 030	150	90	130	12	8	2.5	120 150	75 90	101.5 130	10 12	8 8	2 2	266	67.7	70	18.7 18.8	0.146	0.025 0.024
K 035	150	90	130	12	8	2.5	120 150	75 90	101.5 130	10 12	8 8	2 2	284	70.0	76	21.7 21.8	0.219	0.032 0.031
K 040	180	110	155.5	14	8	2.5	150 180	90 110	130 155.5	12 14	8 8	2 2	316	77.7	82	29.5 29.6	0.312	0.055 0.055
K 045	180	110	155.5	14	8	2.5	150 180	90 110	130 155.5	12 14	8 8	2 2	340	82.2	88	36.4 36.4	0.492	0.083 0.082
K 050	225	140	196	16	8	5	180 225	110 140	155.5 196	14 16	8 8	2 4	380	93.5	97	50.4 50.5	0.780	0.143 0.142
K 055	250	140	218	18	8	6	225 250	140 140	196 218	16 18	8 8	4 4	424	104.1	110	69.6 69.7	1.36	0.242 0.240
K 060	285	175	245	20	8	7	250 285	140 175	218 245	18 20	8 8	4 5	476	117.2	123	99.0 99.5	2.40	0.454 0.453
K 065	315	175	280	22	8	7	285 315	175 175	245 280	20 22	8 8	5 5	534	130.5	137	129 130	4.23	0.768 0.768
K 070	350	220	310	22	10	8	315 350	175 220	280 310	22 22	8 10	5 6	594	142.7	145	175 173	6.47	0.993 0.968
K 075	390	250	345	24	10	8	350 390	220 250	310 345	22 24	10 10	6 6	656	159.5	160	232 230	11.44	2.41 2.38
K 080	435	280	385	27	10	10	390 435	250 280	345 385	24 27	10 10	6 8	726	176.2	177	318 316	19.11	3.80 3.74

Dimensions in mm

Mass and mass moment of inertia are based on the use of steel

Aluminum is available on request

Sizes bigger K 080 are available on request

Dimensions

Series 154

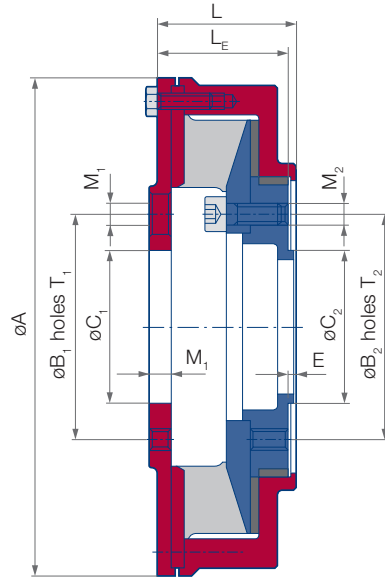

Size	Flange connecting dimensions						Joint shaft connecting dimensions						Mass m [kg]	Mass moments of inertia			
	Flange diameter	C _{1,H7}	B _{1±0,1}	M ₁	T ₁	Flange diameter	C _{2,g7}	B _{2,±0,1}	M ₂	T ₂	E	A		L	L _E	Primary side J _A [kgm ²]	Secondary side J _I [kgm ²]
K 005	90	47	74.5	8	4	90	47	74.5	8	4	2	166	50.2	47.2	4.6	0.014	0.002
K 010	100	57	84	8	6	100	57	84	8	6	2	186	54.7	51.7	6.0	0.023	0.005
K 015	100	57	84	8	6	100	57	84	8	6	2	198	57.8	54.8	7.2	0.033	0.007
K 020	120	75	101.5	10	8	120	75	101.5	10	8	2	226	64.4	61.4	10.2	0.065	0.009
K 025	120	75	101.5	10	8	120	75	101.5	10	8	2	240	66.7	63.7	12.4	0.088	0.013
K 030	150	90	130	12	8	150	90	130	12	8	2	266	77.7	74.7	16.4	0.142	0.026
K 035	150	90	130	12	8	150	90	130	12	8	2	284	80.0	77.0	19.8	0.198	0.032
K 040	180	110	155.5	14	8	180	110	155.5	14	8	2	316	90.7	87.7	26.3	0.315	0.057
K 045	180	110	155.5	14	8	180	110	155.5	14	8	2	340	98.2	95.2	34.7	0.466	0.090
K 050	225	140	196	16	8	225	140	196	16	8	4	380	108.5	104.5	44.3	0.789	0.148
K 055	250	140	218	18	8	250	140	218	18	8	4	424	122.1	118.1	62.2	1.37	0.251
K 060	285	175	245	20	8	285	175	245	20	8	5	476	136.2	132.2	85.6	2.37	0.460
K 065	315	175	280	22	8	315	175	280	22	8	5	534	151.5	147.5	122	4.25	0.830
K 070	350	220	310	22	10	350	220	310	22	10	6	594	166.7	161.7	166	7.30	1.40
K 075	390	250	345	24	10	390	250	345	24	10	6	656	183.5	178.5	223	11.98	2.34
K 080	435	280	385	27	10	435	280	385	27	10	8	726	202.2	197.2	298	19.81	3.80

Dimensions in mm

Mass and mass moment of inertia are based on the use of steel

Aluminum is available on request

Sizes bigger K 080 are available on request

Dimensions

Series 155

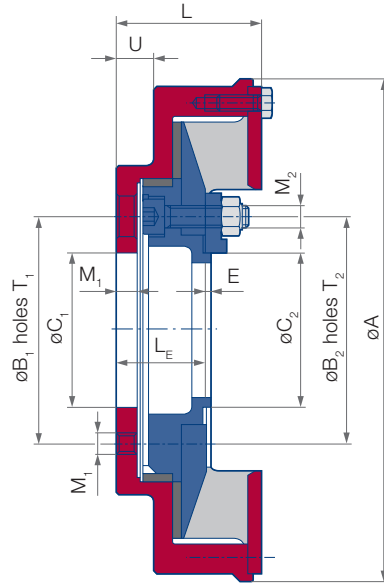

Size	Flange connecting dimensions						Joint shaft connecting dimensions										Mass m [kg]	Mass moments of inertia	
	Flange diameter	$C_{1,H7}$	$B_{1\pm 0,1}$	M_1	T_1	Flange diameter	$C_{2,g7}$	$B_{2\pm 0,1}$	M_2	T_2	E	A	U	L	L_E	Primary side J_A [kgm ²]		Secondary side J_I [kgm ²]	
K 005	90	47	74.5	8	4	90	47	74.5	8	4	2	166	12	49.2	30.0	4.0	0.013	0.002	
K 010	100	57	84	8	6	100	57	84	8	6	2	186	14	53.7	33.0	5.2	0.019	0.004	
K 015	100	57	84	8	6	100	57	84	8	6	2	198	13	56.8	34.8	6.2	0.027	0.006	
K 020	120	75	101.5	10	8	120	75	101.5	10	8	2	226	17	63.4	38.0	9.0	0.053	0.009	
K 025	120	75	101.5	10	8	120	75	101.5	10	8	2	240	17	65.7	40.4	10.7	0.072	0.013	
K 030	150	90	130	12	8	150	90	130	12	8	2	266	21	76.7	46.4	14.6	0.119	0.026	
K 035	150	90	130	12	8	150	90	130	12	8	2	284	21	79.0	47.8	17.1	0.162	0.032	
K 040	180	110	155.5	14	8	180	110	155.5	14	8	2	316	26	89.7	54.3	23.5	0.266	0.055	
K 045	180	110	155.5	14	8	180	110	155.5	14	8	2	340	29	97.2	60.6	30.2	0.383	0.088	
K 050	225	140	196	16	8	225	140	196	16	8	4	380	30	107.5	63.6	39.0	0.652	0.142	
K 055	250	140	218	18	8	250	140	218	18	8	4	424	35	121.1	71.0	55.5	1.16	0.241	
K 060	285	175	245	20	8	285	175	245	20	8	5	476	38	135.2	79.4	75.7	1.97	0.442	
K 065	315	175	280	22	8	315	175	280	22	8	5	534	42	150.5	88.0	108.5	3.55	0.800	
K 070	350	220	310	22	10	350	220	310	22	10	6	594	44	164.7	95.6	147.0	6.04	1.37	
K 075	390	250	345	24	10	390	250	345	24	10	6	656	46	181.5	104.2	195.0	9.80	2.28	
K 080	435	280	385	27	10	435	280	385	27	10	8	726	51	200.2	113.8	261.0	16.23	3.70	

Dimensions in mm

Mass and mass moment of inertia are based on the use of steel

Aluminum is available on request

Sizes bigger K 080 are available on request

Dimensions

Series 157

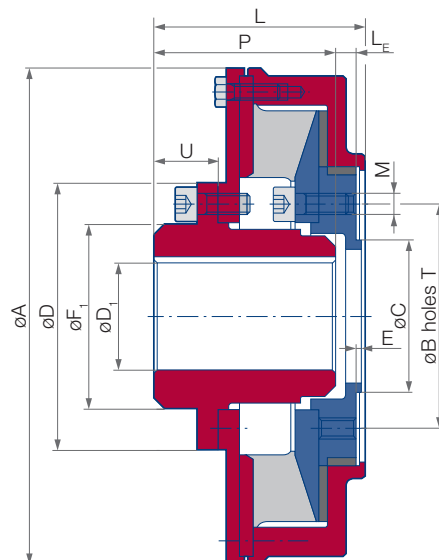

Size	Hub dimensions				Joint shaft connecting dimensions								Mass m [kg]	Mass moments of inertia			
	$D_{1,H7}$	F_1	D	P	Flange diameter	C_{g7}	$B_{\pm 0,1}$	M	T	E	A	U		L	L_E	Primary side J_A [kgm ²]	Secondary side J_I [kgm ²]
K 005	38	58	90	56	90	47	74.5	8	4	2	166	14.8	65	6	5.5	0.015	0.002
K 010	46	69	100	68	100	57	84	8	6	2	186	23.3	78	7	7.2	0.024	0.005
K 015	46	69	100	68	100	57	84	8	6	2	198	23.2	81	10	8.5	0.034	0.007
K 020	56	84	120	82	120	75	101.5	10	8	2	226	29.6	94	9	12.5	0.068	0.009
K 025	56	84	120	82	120	75	101.5	10	8	2	240	29.3	96	11	14.7	0.092	0.013
K 030	74	110	150	112	150	90	130	12	8	2	266	46.3	124	9	21.4	0.155	0.026
K 035	74	110	150	112	150	90	130	12	8	2	284	47.0	127	12	24.9	0.211	0.032
K 040	88	132	180	135	180	110	155.5	14	8	2	316	58.3	149	11	35.4	0.347	0.057
K 045	88	132	180	135	180	110	155.5	14	8	2	340	52.8	151	13	43.8	0.498	0.090
K 050	114	170	225	180	225	140	196	16	8	4	380	88.5	197	13	63.6	0.899	0.148
K 055	126	188	250	195	250	140	218	18	8	4	424	90.9	213	14	88	1.55	0.251
K 060	142	212	285	218	285	175	245	20	8	5	476	100.8	237	15	123	2.71	0.460
K 065	165	244	315	255	315	175	280	22	8	5	534	123.5	275	16	178	4.91	0.828
K 070	185	274	350	285	350	220	310	22	10	6	594	141.3	308	18	244	8.43	1.41
K 075	205	305	390	315	390	250	345	24	10	6	656	155.5	339	19	330	13.89	2.34
K 080	228	342	435	352	435	280	385	27	10	8	726	173.8	376	19	446	23.09	3.80

Dimensions in mm

Mass and mass moment of inertia are based on the use of steel

Aluminum is available on request

Sizes bigger K 080 are available on request

Dimensions

Series 158

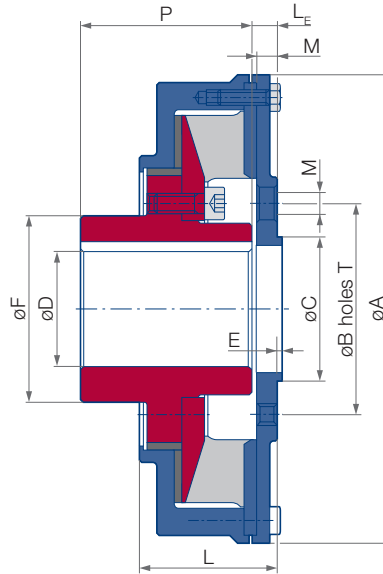

Size	Hub dimensions			Joint shaft connecting dimensions								Mass L_E m [kg]	Mass moments of inertia		
	D_{H7}	F	P	Flange diameter	C_{g7}	$B_{\pm 0,1}$	M	T	E	A	L		Primary side J_A [kgm ²]	Secondary side J_I [kgm ²]	
K 005	38	65	56	90	47	74.5	8	4	2	166	50.2	10	5.3	0.014	0.002
K 010	46	74	68	100	57	84	8	6	2	186	54.7	10	7.0	0.023	0.005
K 015	46	74	68	100	57	84	8	6	2	198	57.8	10	8.3	0.033	0.007
K 020	56	89	82	120	75	101.5	10	8	2	226	64.4	12	12.1	0.065	0.011
K 025	56	89	82	120	75	101.5	10	8	2	240	66.7	12	14.3	0.088	0.015
K 030	74	115	112	150	90	130	12	8	2	266	77.7	14	20.9	0.142	0.036
K 035	74	115	112	150	90	130	12	8	2	284	80.0	14	24.3	0.198	0.042
K 040	88	138	135	180	110	155.5	14	8	2	316	90.7	16	34.4	0.312	0.083
K 045	88	138	135	180	110	155.5	14	8	2	340	98.2	16	41.9	0.466	0.110
K 050	114	176	180	225	140	196	16	8	4	380	108.5	19	62.0	0.789	0.242
K 055	126	195	195	250	140	218	18	8	4	424	122.1	21	85.5	1.37	0.405
K 060	142	220	218	285	175	245	20	8	5	476	136.2	23	119	2.37	0.738
K 065	165	252	255	315	175	280	22	8	5	534	151.5	25	173	4.25	1.39
K 070	185	280	285	350	220	310	22	10	6	594	166.7	25	237	7.30	2.38
K 075	205	312	315	390	250	345	24	10	6	656	183.5	27	322	11.98	4.01
K 080	228	348	352	435	280	385	27	10	8	726	202.2	30	436	19.81	6.69

Dimensions in mm

Mass and mass moment of inertia are based on the use of steel

Aluminum is available on request

Sizes bigger K 080 are available on request

Dimensions

Series 159

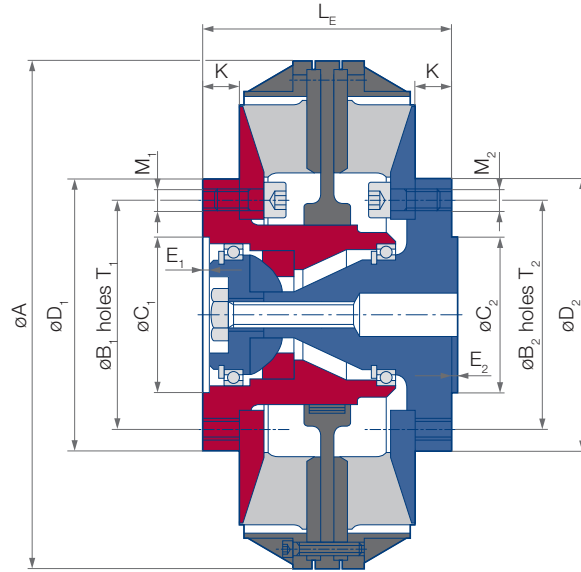

Size	Flange connecting dimensions						Joint shaft connecting dimensions						Mass m [kg]	Mass moments of inertia					
	D ₂	C _{2g7}	B _{2,±0,1}	M ₂	T ₂	E ₂	D ₁	C _{1,g7}	B _{1,±0,1}	M ₁	T ₁	E ₁		A	K	L _E	Primary side J ₁ [kgm ²]	J ₂ [kgm ²]	Secondary side J ₃ [kgm ²]
K 005	90	47	74.5	8	4	2	90	47	74.5	8	4	2.5	166	12	83.4	5.2	0.002	0.007	0.002
K 010	100	57	84	8	6	2	100	57	84	8	6	2.5	186	11	86.4	6.5	0.004	0.013	0.004
K 015	100	57	84	8	6	2	100	57	84	8	6	2.5	198	11	93.6	8	0.006	0.030	0.006
K 020	120	75	101.5	10	8	2	120	75	101.5	10	8	2.5	226	12	100.8	11	0.009	0.034	0.008
K 025	120	75	101.5	10	8	2	120	75	101.5	10	8	2.5	240	14	109.4	13	0.013	0.047	0.012
K 030	150	90	130	12	8	2	150	90	130	12	8	2.5	266	14	120.4	19	0.029	0.075	0.024
K 035	150	90	130	12	8	2	150	90	130	12	8	2.5	284	18	133.0	21.5	0.035	0.109	0.030
K 040	180	110	155.5	14	8	2	180	110	155.5	14	8	2.5	316	17	141.4	31	0.063	0.166	0.054
K 045	180	110	155.5	14	8	2	180	110	155.5	14	8	2.5	340	20	154.4	36.5	0.090	0.243	0.081
K 050	225	140	196	16	8	4	225	140	196	16	8	5	380	20	170.0	52	0.164	0.398	0.147
K 055	250	140	218	18	8	4	250	140	218	18	8	6	424	24	194.2	72	0.264	0.688	0.249
K 060	285	175	245	20	8	5	285	175	245	20	8	7	476	25	213.4	102	0.502	1.20	0.472

Dimensions in mm

Mass and mass moment of inertia are based on the use of steel

Aluminum is available on request

Sizes bigger K 060 are available on request

Dimensions

Series 160

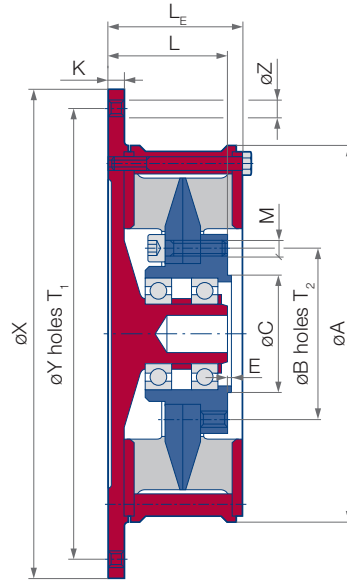

Size	Flywheel SAE J620	Flywheel connecting dimensions					Joint shaft connecting dimensions							Mass m [kg]	Mass moments of inertia			
		X _{g7}	Y _{±0.2}	Z	T ₁	K	Flange diameter	C _{g7}	B _{±0.1}	M	T ₂	E	A		L	L _E	Primary side J _A [kgm ²]	Secondary side J _I [kgm ²]
K 005	6.5	215.9	200.0	9	6	8	90	47	74.5	8	4	2	166	61.2	56	7.5	0.028	0.003
	7.5	241.3	222.3	9	8	8										8.0	0.035	
K 010	7.5	241.3	222.3	9	8	8	100	57	84	8	6	2	186	66.0	61	9.5	0.043	0.007
	8	263.5	244.5	11	6	8										10.0	0.052	
K 015	7.5	241.3	222.3	9	8	8	100	57	84	8	6	2	198	72.2	66	11.2	0.056	0.011
	8	263.5	244.5	11	6	10										12.2	0.070	
K 020	8	263.5	244.5	11	6	10	120	75	101.5	10	8	2	226	81.2	75	16.1	0.103	0.015
	10	314.3	295.3	11	8	10										17.9	0.141	
K 025	10	314.3	295.3	11	8	10	120	75	101.5	10	8	2	240	86.8	81	20.5	0.162	0.023
	11.5	352.4	333.4	11	8	10										22.1	0.206	
K 030	10	314.3	295.3	11	8	11	150	90	130	12	8	2	266	101.4	94	28.2	0.225	0.045
	11.5	352.4	333.4	11	8	11										28.6	0.273	
	14	466.7	438.2	14	8	12										35.8	0.575	
K 035	11.5	352.4	333.4	11	8	12	150	90	130	12	8	2	284	102.0	95	33.2	0.340	0.057
	14	466.7	438.2	14	8	12										40.1	0.634	
K 040	11.5	352.4	333.4	11	8	18	180	110	155.5	14	8	2	316	112.2	104	43.7	0.505	0.097
	14	466.7	438.2	14	8	12										49.7	0.774	
K 045	14	466.7	438.2	14	8	12	180	110	155.5	14	8	2	340	122.0	114	55.5	0.904	0.153
K 050	14	466.7	438.2	14	8	14	225	140	196	16	8	4	380	132.2	123	75.3	1.28	0.259
	16	517.5	489.0	14	8	14										79.6	1.57	
K 055	14	466.7	438.2	14	8	22	250	140	218	18	8	4	424	152.0	142	102.6	2.09	0.444
	16	517.5	489.0	14	8	14										105	2.25	
K 060	16	517.5	489.0	14	8	12	285	175	245	20	8	5	476	171.8	161	136	3.25	0.819
	18	571.5	542.9	18	6	16										143	3.74	
K 065	21	673.1	641.4	18	6	18	315	175	280	22	8	5	534	192.0	180	208	7.22	1.47
	24	733.4	692.2	20	12	18										217	8.38	
K 070	21	673.1	641.4	18	12	16	350	220	310	22	10	6	594	212.0	198	270	10.55	2.57
	24	733.4	692.2	20	12	18										280	11.83	
K 075	24	733.4	692.2	20	12	18	390	250	345	24	10	6	656	232.0	216	356	16.53	4.30
K 080	-	798.0	762.0	24	12	34	435	280	385	27	10	8	726	262.0	244	492	28.55	7.12

Dimensions in mm

Mass and mass moment of inertia are based on the use of steel

Aluminum is available on request

Sizes bigger K 080 are available on request

Dimensions

Series 161

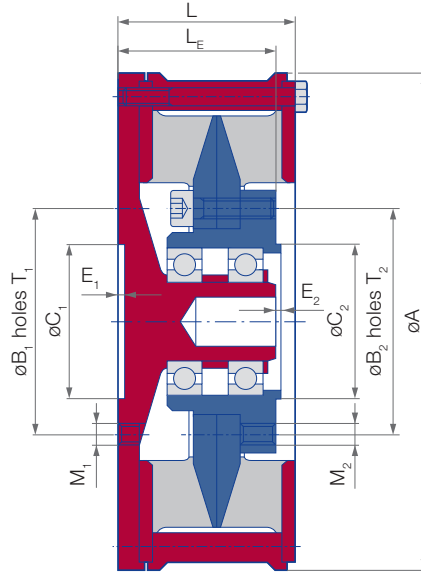

Size	Flange connecting dimensions						Joint shaft connecting dimensions						Mass	Mass moments of inertia				
	Flange diameter	$C_{1,H7}$	$B_{1\pm 0,1}$	M_1	T_1	E_1	Flange diameter	$C_{2,g7}$	$B_{2\pm 0,1}$	M_2	T_2	E_2		A	L	L_E	m [kg]	Primary side J_A [kgm ²]
K 005	90	47	74.5	8	4	2.5	90	47	74.5	8	4	2	166	61.2	56	6.5	0.019	0.003
K 010	100	57	84	8	6	2.5	100	57	84	8	6	2	186	66.0	61	8.3	0.030	0.007
K 015	100	57	84	8	6	2.5	100	57	84	8	6	2	198	72.2	66	10.3	0.045	0.011
K 020	120	75	101.5	10	8	2.5	120	75	101.5	10	8	2	226	81.2	75	15	0.086	0.015
K 025	120	75	101.5	10	8	2.5	120	75	101.5	10	8	2	240	86.8	81	18	0.113	0.023
K 030	150	90	130	12	8	2.5	150	90	130	12	8	2	266	101.4	94	25	0.185	0.045
K 035	150	90	130	12	8	2.5	150	90	130	12	8	2	284	102.0	95	30	0.258	0.057
K 040	180	110	155.5	14	8	2.5	180	110	155.5	14	8	2	316	112.2	104	41	0.430	0.097
K 045	180	110	155.5	14	8	2.5	180	110	155.5	14	8	2	340	122.0	114	48	0.591	0.153
K 050	225	140	196	16	8	5	225	140	196	16	8	4	380	132.2	123	69	1.03	0.259
K 055	250	140	218	18	8	6	250	140	218	18	8	4	424	152.0	142	97.5	1.83	0.444
K 060	285	175	245	20	8	7	285	175	245	20	8	5	476	171.8	161	133	3.06	0.819
K 065	315	175	280	22	8	7	315	175	280	22	8	5	534	192	180	189	5.52	1.47
K 070	350	220	310	22	10	8	350	220	310	22	10	6	594	212	198	260	9.56	2.57
K 075	390	250	345	24	10	8	390	250	345	24	10	6	656	232	216	344	15.09	4.30
K 080	435	280	385	27	10	10	435	280	385	27	10	8	726	262	244	470	25.43	7.12

Dimensions in mm

Mass and mass moment of inertia are based on the use of steel

Aluminum is available on request

Sizes bigger K 080 are available on request

Dimensions

Series 170

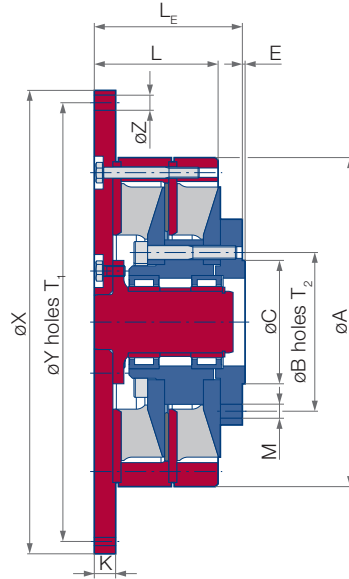

Size	Flywheel SAE J620	Flywheel connecting dimensions					Joint shaft connecting dimensions							Mass m [kg]	Mass moments of inertia			
		X _{g7}	Y _{±0,2}	Z	T ₁	K	Flange diameter	C _{g7}	B _{±0,1}	M	T ₂	E	A		L	L _E	Primary side J _A [kgm ²]	Secondary side J _I [kgm ²]
K 005	6.5	215.9	200.0	9	6	8	90	47	74.5	8	4	2	166	47.2	83	7.9	0.025	0.004
	7.5	241.3	222.3	9	8	8										8.4	0.032	0.004
K 010	7.5	241.3	222.3	9	8	8	90	47	74.5	8	4	2	186	48.7	84	10.3	0.042	0.009
	8	263.5	244.5	11	6	8										10.8	0.050	0.009
K 015	7.5	241.3	222.3	9	8	8	90	47	74.5	8	4	2	198	52.8	90	12.1	0.052	0.013
	8	263.5	244.5	11	6	10										12.5	0.060	0.013
K 020	8	263.5	244.5	11	6	10	100	57	84	8	6	2	226	57.4	101	16.9	0.092	0.018
	10	314.3	295.3	11	8	10										18.6	0.128	0.018
K 025	10	314.3	295.3	11	8	10	100	57	84	8	6	2	240	57.7	104	21.0	0.150	0.026
	11.5	352.4	333.4	11	8	10										22.4	0.192	0.026
K 030	10	314.3	295.3	11	8	11	120	75	101.5	10	8	2	266	67.7	122	27.7	0.198	0.055
	11.5	352.4	333.4	11	8	11										29.4	0.245	0.055
	14	466.7	438.2	14	8	12										36.5	0.538	0.055
K 035	11.5	352.4	333.4	11	8	12	120	75	101.5	10	8	2	284	70.0	123	32.8	0.298	0.067
	14	466.7	438.2	14	8	12										39.8	0.590	0.067
K 040	11.5	352.4	333.4	11	8	18	150	90	130	12	8	2	316	78.7	145	45.9	0.447	0.123
	14	466.7	438.2	14	8	12										50.0	0.708	0.123
K 045	14	466.7	438.2	14	8	12	180	110	155.5	14	8	2	340	82.2	146	58.4	0.835	0.172
																58.4	0.835	0.173
K 050	14	466.7	438.2	14	8	14	180	110	155.5	14	8	2	380	92.5	164	74.8	1.12	0.315
	16	517.5	489.0	14	8	14										78.9	1.38	0.313
K 055	14	466.7	438.2	14	8	22	225	140	196	16	8	2	416	102.1	182	95.5	1.69	0.520
	16	517.5	489.0	14	8	14										101	1.97	0.520
K 060	16	517.5	489.0	14	8	12	250	140	218	18	8	4	466	112.2	207	130	2.79	0.973
	18	571.5	542.9	18	6	16										138	3.41	0.971
K 065	21	673.1	641.4	18	12	18	285	175	245	20	8	5	534	122.5	224	203	6.29	1.77
	24	733.4	692.2	20	12	18										213	7.45	1.77
K 070	21	673.1	641.4	18	12	16	315	175	280	22	8	5	594	142.7	260	265	9.22	3.03
	24	733.4	692.2	20	12	18										272	10.35	3.02
K 075	24	733.4	692.2	20	12	18	350	220	310	22	10	6	656	152.5	274	352	13.90	5.23
																350	13.90	5.21
K 080	-	798.0	762.0	24	12	34	390	250	345	24	10	6	726	172.2	309	474	24.47	8.27
																435	280	385

Dimensions in mm

Mass and mass moment of inertia are based on the use of steel

Aluminum is available on request

Sizes bigger K 080 are available on request

Dimensions

Series 171

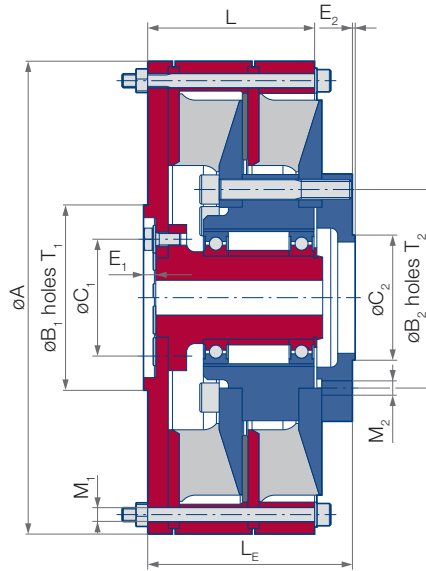

Size	Flange connecting dimensions						Joint shaft connecting dimensions						Mass m [kg]	Mass moments of inertia				
	Flange diameter	C _{1,H7}	B _{1±0,1}	M ₁	T ₁	E ₁	Flange diameter	C _{2,g7}	B _{2±0,1}	M ₂	T ₂	E ₂		A	L	L _E	Primary side J _A [kgm ²]	Secondary side J _I [kgm ²]
K 005	90	47	74.5	8	4	2.5	90	47	74.5	8	4	2	166	47.2	83	7.1	0.017	0.004
K 010	100	57	84	8	6	2.5	90	47	74.5	8	4	2	186	48.7	84	9.3	0.03	0.009
							100	57	84	8	6	2				9.3	0.03	0.009
K 015	100	57	84	8	6	2.5	90	47	74.5	8	4	2	198	52.8	90	11.2	0.041	0.013
							100	57	84	8	6	2				11.2	0.041	0.013
K 020	120	75	101.5	10	8	2.5	100	57	84	8	6	2	226	57.4	101	16.2	0.078	0.018
							120	75	101.5	10	8	2				16.1	0.078	0.018
K 025	120	75	101.5	10	8	2.5	100	57	84	8	6	2	240	57.7	104	18.4	0.102	0.026
							120	75	101.5	10	8	2				18.3	0.102	0.026
K 030	150	90	130	12	8	2.5	120	75	101.5	10	8	2	266	67.7	122	26.7	0.164	0.055
							150	90	130	12	8	2				26.8	0.164	0.055
K 035	150	90	130	12	8	2.5	120	75	101.5	10	8	2	284	70.0	123	30.5	0.232	0.067
							150	90	130	12	8	2				30.6	0.232	0.067
K 040	180	110	155.5	14	8	2.5	150	90	130	12	8	2	316	78.7	145	45.7	0.394	0.123
							180	110	155.5	14	8	2				45.8	0.394	0.123
K 045	180	110	155.5	14	8	2.5	150	90	130	12	8	2	340	82.2	146	52.1	0.548	0.172
							180	110	155.5	14	8	2				52.2	0.548	0.173
K 050	225	140	196	16	8	5	180	110	155.5	14	8	2	380	92.5	164	70.3	0.909	0.315
							225	140	196	16	8	4				70.0	0.909	0.313
K 055	250	140	218	18	8	6	225	140	196	16	8	2	424	102.1	182	90.9	1.42	0.520
							250	140	218	18	8	4				90.9	1.42	0.520
K 060	285	175	245	20	8	7	250	140	218	18	8	4	476	112.2	207	123.5	2.35	0.973
							285	175	245	20	8	5				123.0	2.35	0.971
K 065	315	175	280	22	8	7	285	175	245	20	8	5	534	122.5	224	182.0	4.51	1.77
							315	175	280	22	8	5				182.0	4.51	1.77
K 070	350	220	310	22	10	8	315	175	280	22	8	5	594	142.7	260	258.0	8.31	3.03
							350	220	310	22	10	6				256.0	8.31	3.02
K 075	390	250	345	24	10	8	350	220	310	22	10	6	656	152.5	274	331.0	12.20	5.23
							390	250	345	24	10	6				329.0	12.20	5.21
K 080	435	280	385	27	10	10	390	250	345	24	10	6	726	172.2	309	456.0	21.60	8.27
							435	280	385	27	10	8				454.0	21.60	8.24

Dimensions in mm

Mass and mass moment of inertia are based on the use of steel

Aluminum is available on request

Sizes bigger K 080 are available on request

Dimensions

Series 172

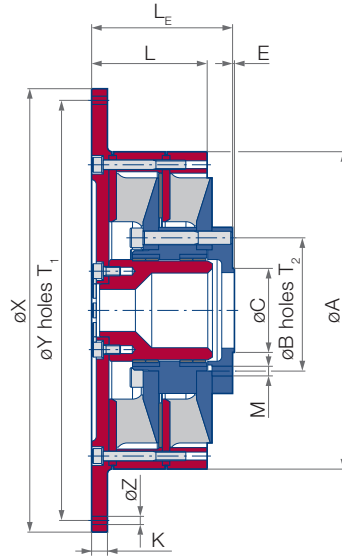

Size	Flywheel connecting dimensions						Joint shaft connecting dimensions								Mass m [kg]	Mass moments of inertia	
	Flange diameter SAE J620	X _{g7}	Y _{±0,2}	Z	T ₁	K	Flange diameter	C _{g7}	B _{±0,1}	M	T ₂	E	A	L		L _E	Primary side J _A [kgm ²]
K 005	6.5	215.9	200	9	6	8	90	47	74.5	8	4	2	166	45.2	81	7.9	0.025
	7.5	241.3	222.3	9	8	8										8.4	0.032
K 010	7.5	241.3	222.3	9	8	8	90	47	74.5	8	4	2	186	47.7	84	10.3	0.042
	8	263.5	244.5	11	6	8	100	57	84	8	6	2				10.8	0.050
K 015	7.5	241.3	222.3	9	8	8	90	47	74.5	8	4	2	198	51.8	90	12.1	0.052
	8	263.5	244.5	11	6	10	100	57	84	8	6	2				12.5	0.060
K 020	8	263.5	244.5	11	6	10	100	57	84	8	6	2	226	56.4	101	16.9	0.092
	10	314.3	295.3	11	8	10	120	75	101.5	10	8	2				18.6	0.128
K 025	10	314.3	295.3	11	8	10	100	57	84	8	6	2	240	58.7	105	21	0.150
	11.5	352.4	333.4	11	8	10	120	75	101.5	10	8	2				22.4	0.192
K 030	10	314.3	295.3	11	8	11	120	75	101.5	10	8	2				27.7	0.198
	11.5	352.4	333.4	11	8	11	120	75	101.5	10	8	2	266	66.7	120	29.4	0.245
	14	466.7	438.2	14	8	12	150	90	130	12	8	2				36.5	0.538
K 035	11.5	352.4	333.4	11	8	12	120	75	101.5	10	8	2	284	69	124	32.8	0.298
	14	466.7	438.2	14	8	12	150	90	130	12	8	2				39.8	0.590
K 040	11.5	352.4	333.4	11	8	18	150	90	130	12	8	2	316	76.7	138	45.9	0.447
	14	466.7	438.2	14	8	12	180	110	155.5	14	8	2				50	0.708
K 045	14	466.7	438.2	14	8	12	150	90	130	12	8	2	340	81.2	146	58.4	0.835
							180	110	155.5	14	8	2				58.4	0.835
K 050	14	466.7	438.2	14	8	14	180	110	155.5	14	8	2	380	91.5	165	74.8	1.12
	16	517.5	489	14	8	14	225	140	196	16	8	2				78.9	1.38
K 055	14	466.7	438.2	14	8	22	225	140	196	16	8	4	416	102.1	181	95.5	1.69
	16	517.5	489	14	8	14	250	140	218	18	8	4	424			101	1.97
K 060	16	517.5	489	14	8	12	250	140	218	18	8	4	466	113.2	208	130	2.79
	18	571.5	542.9	18	6	16	285	175	245	20	8	5	476			138	3.41
K 065	21	673.1	641.4	18	12	18	285	175	245	20	8	5	534	125.5	229	203	6.29
	24	733.4	692.2	20	12	18	315	175	280	22	8	5				213	7.45
K 070	21	673.1	641.4	18	12	16	315	175	280	22	8	5	594	141.7	258	265	9.22
	24	733.4	692.2	20	12	18	350	220	310	22	10	6				272	10.35
K 075	24	733.4	692.2	20	12	18	350	220	310	22	10	6	656	155.5	287	352	13.90
							390	250	345	24	10	6				350	13.90
K 080	-	798	762	24	12	34	390	250	345	24	10	6	726	172.2	311	474	24.47
							435	280	385	27	10	6				474	24.47

Dimensions in mm

Mass and mass moment of inertia are based on the use of steel

Aluminum is available on request

Sizes bigger K 080 are available on request

Dimensions

Series 173

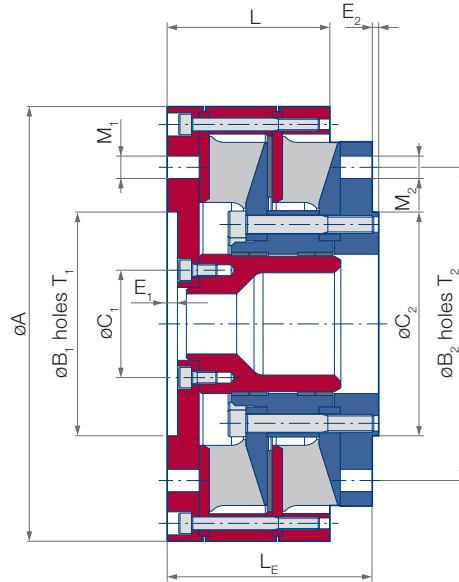

Size	Flywheel connecting dimensions						Joint shaft connecting dimensions						Mass m [kg]	Mass moments of inertia				
	Flange diameter	C _{1,H7}	B _{1,±0,1}	M ₁	T ₁	E ₁	Flange diameter	C _{2,g7}	B _{2,±0,1}	M ₂	T ₂	E ₂		A	L	L _E	Primary side J _A [kgm ²]	Secondary side J _I [kgm ²]
005	90	47	74.5	8	4	2.5	90	47	74.5	8	4	2	166	47	48	6.9	0.016	0.002
010	100	57	84	8	6	2.5	90 100	47 57	74.5 84	8 8	4 6	2 2	186	49.7	52	9.1	0.029	0.004
015	100	57	84	8	6	2.5	90 100	47 57	74.5 84	8 8	4 6	2 2	198	52.8	54	11.1	0.041	0.006
020	120	75	101.5	10	8	2.5	100 120	57 75	84 101.5	8 10	6 8	2 2	226	58.4	63	15.8	0.075	0.008
025	120	75	101.5	10	8	2.5	100 120	57 75	84 101.5	8 10	6 8	2 2	240	60.7	64	18.5	0.100	0.012
030	150	90	130	12	8	2.5	120 150	75 90	101.5 130	10 12	8 8	2 2	266	67.7	71	25.7	0.154	0.025
035	150	90	130	12	8	2.5	120 150	75 90	101.5 130	10 12	8 8	2 2	284	70.8	76	29.6	0.216	0.032
040	180	110	155.5	14	8	2.5	150 180	90 110	130 155.5	12 14	8 8	2 2	316	77.7	85	43.8	0.390	0.055
045	180	110	155.5	14	8	2.5	150 180	90 110	130 155.5	12 14	8 8	2 2	340	82.2	89	50.9	0.520	0.083
050	225	140	196	16	8	5	180 225	110 140	155.5 196	14 16	8 8	2 2	380	93.5	98	68.5	0.840	0.143
055	250	140	218	18	8	6	225 250	140 140	196 218	16 18	8 8	2 4	424	104.1	110	90.6	1.44	0.242
060	285	175	245	20	8	7	250 285	140 175	218 245	18 20	8 8	4 5	476	117.2	123	125	2.43	0.454
065	315	175	280	22	8	7	285 315	175 175	245 280	20 22	8 8	5 5	534	130.5	137	187	4.77	0.768
070	350	220	310	22	10	8	315 350	175 220	280 310	22 22	8 10	5 6	594	142.7	154	253	8.10	0.993
075	390	250	345	24	10	8	350 390	220 250	310 345	22 24	10 10	6 6	656	159.5	166	339	12.30	2.41
080	435	280	385	27	10	10	435 435	250 280	345 385	24 27	10 10	6 8	726	176.2	182	458	22.12	3.80

Dimensions in mm

Mass and mass moment of inertia are based on the use of steel

Aluminum is available on request

Sizes bigger K 080 are available on request

Dimensions

Series 190

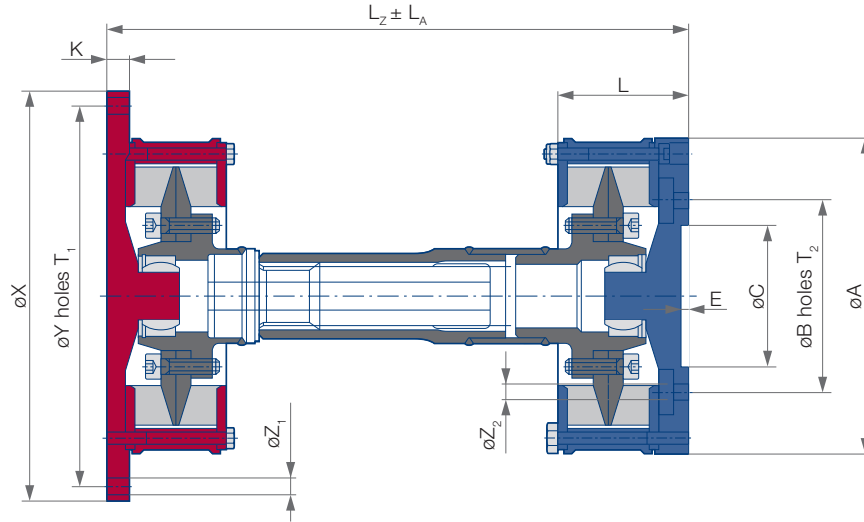

Size	Flywheel	Flywheel connecting dimensions						Flange connecting dimensions						Mass		Mass moments of inertia				
		SAE J620	X_{g7}	$Y_{\pm 0,1}$	Z_1	T_1	K	C_{H7}	$B_{\pm 0,1}$	Z_2	T_2	E	A	L	L_z	L_A	m_1 [kg]	m_2 [kg]	Primary side J_1 [kgm ²]	Primary side J_2 [kgm ²]
K 005	6.5	215.9	200.0	9	6	8	75	101.5	9	8	2.5	166	70	355	30	9.8	7.7	0.035	0.012	0.013
	7.5	241.3	222.3	9	8	8												0.042		
K 010	7.5	241.3	222.3	9	8	8	75	101.5	9	8	2.5	186	74	420	90	13.3	11.2	0.053	0.016	0.018
	8	263.5	244.5	11	6	10												0.068		
K 015	7.5	241.3	222.3	9	8	8	90	130	11	8	2.5	198	84	430	90	15.3	13.7	0.071	0.024	0.045
	8	263.5	244.5	11	6	10												0.083		
K 020	8	263.5	244.5	11	6	10	90	130	11	8	2.5	226	89	435	90	20.8	17.8	0.127	0.032	0.086
	10	341.3	295.3	11	8	10												0.165		
K 025	10	341.3	295.3	11	8	10	110	155.5	13	8	2.5	240	98	430	100	26.2	22.6	0.194	0.049	0.123
	11.5	352.4	333.4	11	8	10												0.238		
K 030	10	314.3	295.3	11	8	12	110	155.5	13	8	2.5	266	107	485	110	34.6	31.3	0.266	0.097	0.207
	11.5	352.4	333.4	11	8	12												0.318		
K 035	11.5	352.4	333.4	11	8	12	140	196	17	8	4	284	116	505	110	41.4	37.7	0.390	0.124	0.273
	14	466.7	438.2	14	8	12												0.684		
K 040	11.5	352.4	333.4	11	8	14	140	196	17	8	4	316	125	540	110	52.1	50.4	0.553	0.202	0.455
	14	466.7	438.2	14	8	12												0.839		
K 045	14	466.7	438.2	14	8	12	140	196	17	8	4	340	134	550	100	67.9	60.4	0.997	0.311	0.624
	16	517.5	489.0	14	8	14												1.48		
K 050	14	466.7	438.2	14	8	14	140	196	17	8	4	380	148	640	110	92.8	83.6	1.74	0.530	1.04
	16	517.5	489.0	14	8	14												2.39		
K 055	14	466.7	438.2	14	8	21	175	245	21	8	6	424	171	660	120	124	115	2.57	0.890	1.89
	16	517.5	489.0	14	8	14												3.92		
K 060	16	517.5	489.0	14	8	23	175	245	21	8	6	476	187	770	90	171	161	4.32	1.68	3.16
	18	571.5	542.9	18	6	18												7.85		
K 065	21	673.1	641.4	18	12	16	220	310	21	10	6	534	205	985	140	262	236	9.20	3.21	5.55
	24	733.4	692.2	20	12	18												12.34		
K 070	21	673.1	641.4	18	12	18	220	310	21	10	6	594	225	1025	140	341	311	13.50	5.33	9.58
	24	733.4	692.2	20	12	18												13.50		

Dimensions in mm

Mass and mass moment of inertia are based on the use of steel

Aluminum is available on request

Sizes bigger K 070 are available on request

Maximum admissible speeds

Series	BR 151, 153, 159*, 160, 161, 170*, 171*, 190			BR 150, 152, 154, 155, 157, 158, 172, 173	
Size	Aluminum	C 45	GGG 40	C 45	GGG 40
K 005	13300	11800	10100	3000	3000
K 010	11500	10400	8900	3000	3000
K 015	10500	9600	8200	3000	3000
K 020	9700	8700	7400	3000	3000
K 025	9000	8100	6900	3000	3000
K 030	8000	7200	6200	3000	3000
K 035	7400	6700	5700	3000	3000
K 040	6800	6100	5200	3000	3000
K 045	6100	5600	4800	3000	3000
K 050	5600	5000	4300	3000	3000
K 055	5000	4500	3800	3000	3000
K 060	4300	3900	3400	3000	3000
K 065	3900	3500	3000	3000	3000
K 070	3400	3100	2700	3000	2700
K 075	3100	2800	2400	2800	2400
K 080	2800	2500	2200	2500	2200
K 085	2500	2300	1900	2300	1900
K 090	2200	2000	1700	2000	1700

*applies to designs in which the element is surrounded by a casing; other (lower) maximum speeds are applicable for other designs

All speeds stated in rpm

Higher speeds available on request with special designs

Speeds for sizes bigger K 090 available on request

Admissible shaft misalignments

Size	Maximum admissible radial misalignment during load peaks [mm]	Continuous admissible radial misalignment r at 600 rpm [mm]	Continuous admissible axial misalignment [mm]	Continuous admissible angular misalignment at 600 rpm [°]
				BR 190
K 005	1.5	1.0	0.9	0.5
K 010	1.5	1.2	1.0	0.5
K 015	1.7	1.3	1.2	0.5
K 020	3.0	1.4	1.4	0.5
K 025	3.5	1.5	1.5	0.5
K 030	4.0	1.6	1.7	0.5
K 035	4.0	1.7	1.8	0.5
K 040	4.0	1.8	2.0	0.5
K 045	4.0	2.0	2.1	0.5
K 050	5.0	2.2	2.3	0.5
K 055	5.0	2.4	2.8	0.5
K 060	5.0	2.7	3.1	0.5
K 065	5.0	3.0	3.5	0.5
K 070	5.0	3.5	3.9	0.5
K 075	6.0	3.6	4.3	0.5
K 080	6.0	4.0	4.8	0.5
K 085	6.0	4.4	5.3	0.5
K 090	7.0	4.8	6.0	0.5

The recommended alignment tolerances are 10% of the stated admissible shaft misalignment.

Radial displacement of couplings:

The admissible radial displacements for couplings can be stated only with reference to one determined speed since any radial displacement causes additional thermal stress.

The continuous displacement is stated for 600 rpm; at higher speeds n_x ,

$$r_{\text{adm}} = r \cdot \sqrt{\frac{600}{n_x}}, \quad n_x: \text{max. speed}$$

Voith Group
St. Poeltener Str. 43
89522 Heidenheim
Germany

www.voith.com/highflex

Contact:
Phone +49 201 557-8361
highflex@voith.com



VOITH